

ThermTec

HUNT Series

Thermal Clip-On Hunt Series User Manual



Download on the
App Store



GET IT ON
Google Play



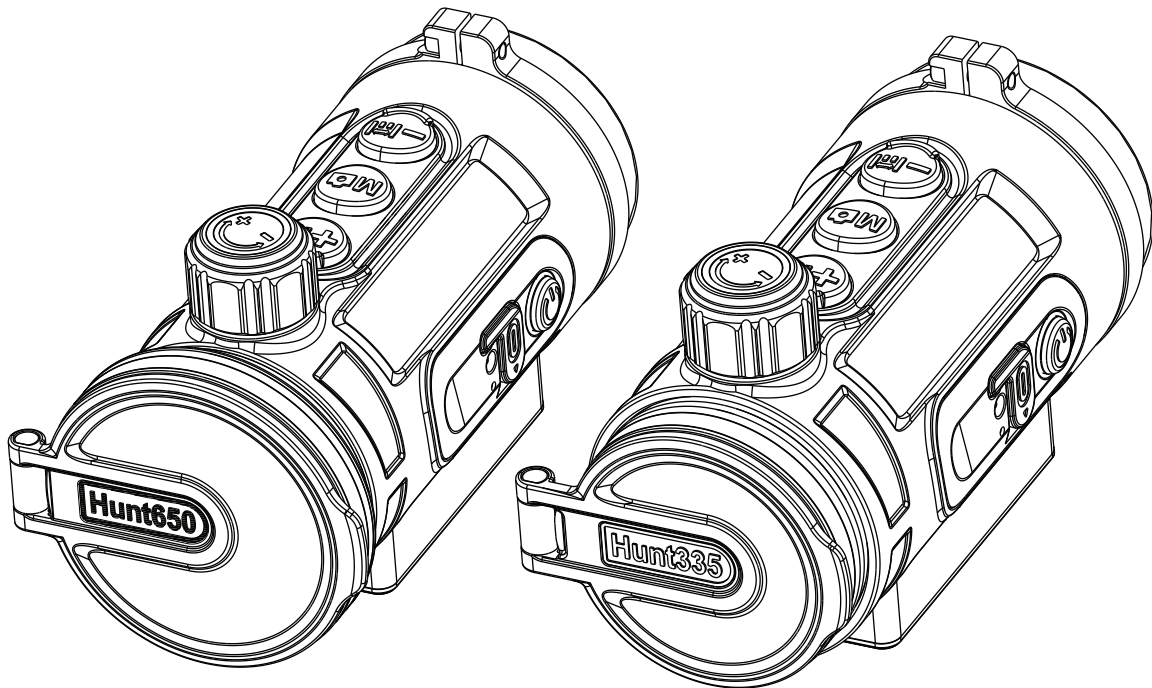

Legal Information

COPYRIGHT © 2023 ThermTec Technology Co., Ltd. ALL RIGHTS RESERVED.

About this Manual

The Manual includes instructions for using and managing the product, pictures, charts, images and all other information hereinafter are for explanation and description only. The information contained in the Manual is subject to change, without notice due to firmware updates or other reasons. Please find the latest version of this Manual at the ThermTec website (<https://www.thermeyetec.com>).

Please use this Manual with the guidance and assistance of professionals trained in supporting the product.

Trademarks

ThermTec and other ThermTec's trademarks and logos are the properties of ThermTec in various jurisdictions. Other trademarks and logos mentioned are the properties of their respective owners.

Disclaimer

To the maximum extent permitted by applicable law, this Manual and the product described, with its hardware, software and firmware, are provided "As is" and "With all faults and errors". ThermTec makes no warranties, express or implied, including without limitation, merchantability, satisfactory quality, or fitness for a particular purpose. The use of the product by you is at your own risk. In no event will ThermTec be liable to you for any special, consequential, incidental, or indirect damages, including, among others, damages for loss of business profits, business interruption, or loss of data, corruption of systems, or loss of documentation, whether based on breach of contract, tort (including negligence), product liability, or otherwise, in connection with the use of the product, even if ThermTec has been advised of the possibility of such damages or loss.

You acknowledge that the nature of the internet provides for inherent security risks, and ThermTec shall not take any responsibilities for abnormal operation, privacy leakage or other damages resulting from cyber-attack, hacker attack, virus infection, or other internet security risks; however, ThermTec will provide timely technical support if required.

You agree to use this product in compliance with all applicable laws, and you are solely responsible for ensuring that your use conforms to the applicable law. Especially, you are responsible, for using this product in a manner that does not infringe on the rights of third parties, including without limitation, rights of publicity, intellectual property rights, or data protection and other privacy rights. You shall not use this product for any prohibited end-uses, including the development or production of weapons of mass destruction, the development or production of chemical or biological weapons, any activities in the context related to any nuclear explosive or unsafe nuclear fuel-cycle, or in support of human rights abuses.

In the event of any conflicts between this manual and the applicable law, the latter prevails.

The logo for ThermTec features a stylized 'T' icon on the left, composed of three vertical bars of varying heights and two horizontal bars. To the right of the icon, the word 'ThermTec' is written in a bold, black, sans-serif font.The logo for HUNT consists of the word 'HUNT' in a bold, black, sans-serif font. A vertical line is positioned to the left of the text, separating it from the ThermTec logo.

Content

SAFETY INFORMATION	06	6.6 Pseudo Color Switch	18
REGULATORY INFORMATION	08	6.7 Target Outline Mode	18
1. DESCRIPTION	09	6.8 UI Zooming	18
2. FEATURES	09	6.9 AI Rangefinder	19
3. SPECIFICATIONS	10	6.10 OLED Brightness Adjustment	19
4. PACKING LIST	11	6.11 OSD Function	19
5. COMPONENTS AND CONTROLS	12	7. MAIN MENU	20
5.1 Appearance of Hunt	12	8. ZEROING	29
5.2 Description of Controls	13	9. CAPTURING AND RECORDING	31
5.3 Menu/Status Bar Icons	14	10. MEMORY ACCESS	33
6. OPERATION GUIDE	15	11. HOTSPOT FUNCTION	33
6.1 Installation	15	12. REMOTE CONTROL	35
6.2 Power On/Off	17	13. DOWNLOAD “ThermTec Outdoor” APP	36
6.3 Image Correction	17	14. TECHNICAL INSPECTION	37
6.4 Standby Mode	17	15. MAINTENANCE	37
6.5 Lens Focus Adjustment	17	16. FIRMWARE UPGRADE	37

SAFETY INFORMATION

Environmental influences

Notes: Never point the lens of the device directly at intense heat sources such as the sun or laser equipment. The objective lens and eyepiece can function as a burning glass and damage the interior components.

Risk of swallowing

Caution: Do not place this device in the hands of small children. Incorrect handling can cause small parts to come loose which may be swallowed.

Safety instructions for use

- Do not expose the device to fire or high temperatures.
- The battery capacity decreases when operated in a cold ambient temperature. This is not a fault and occurs for technical reasons.
- Always store the device in a dry, well-ventilated space. For prolonged storage, remove the batteries.
- Do not expose your device to extreme temperatures lower than - 20°C and higher than + 50°C.
- The product shall only be connected to a USB Type C interface.
- If the device has been damaged or the battery is defective, send the device to our after-sales service for repair.

User information on the disposal of electrical and electronic devices (private households)

The WEEE symbol on products and/or accompanying documents indicates that used electrical and electronic products must not be mixed with ordinary household waste. For proper treatment, recovery and recycling, take these products to the appropriate collection points where they will be accepted without charge. In some countries, it may also be possible to return these products to your local retailer when you purchase a corresponding new product. The proper

disposal of this product serves to protect the environment and prevents possible harmful effects on human beings and their surroundings, which may arise as a result of incorrect handling of waste.

More detailed information on your nearest collection point is available from your local authority. In accordance with state legislation, penalties may be imposed for the improper disposal of this type of waste.

For business customers within the European Union

Please contact your dealer or supplier regarding the disposal of electrical and electronic devices from which could provide you with further information.

Information on disposal in other countries outside of the European Union

This symbol is only applicable in the European Union. Please contact your local authority or dealer if you wish to dispose of this product and ask for a disposal option.

Intended use

The device is intended for displaying heat signatures during nature observation, remote hunting observations and for civil use. This device is not a toy for children.

Use the device only as described in this instruction manual. The manufacturer and the dealer accept no liability for damages which arise due to non-intended or incorrect use.

Function test

- Before use, please ensure that your device has no visible damage.
- Test to see if the device displays a clear, undisturbed image.
- Check that the settings for the thermal imaging camera are correct. See the notes in the Operation section .

REGULATORY INFORMATION



This product and - if applicable - the supplied accessories too are marked with "CE" and comply therefore with the applicable harmonized European standards listed under the Directive 2014/53/EU(RED), Directive 2014/30/EU(EMC), Directive 2014/35/EU(LVD), Directive 2011/65/EU(RoHS).



This product and - if applicable - the supplied accessories too are marked with "UKCA" and comply therefore with the following directives: Radio Equipment Regulations 2017, Electromagnetic Compatibility Regulations 2016, Electrical Equipment (Safety) Regulations 2016, the Restriction of the Use of Certain Hazardous Substances in Electrical and Electronic Equipment Regulations 2012.



This product and - if applicable - the supplied accessories too are marked with "RoHS" and comply therefore the requirements of Directive 2011/65/EU on the restriction of the use of certain hazardous substances in electrical and electronic equipment ("RoHS recast" or "RoHS 2").



2012/19/EU (WEEE directive): Products marked with this symbol cannot be disposed of as unsorted municipal waste in the European Union. For proper recycling, return this product to your local supplier upon the purchase of equivalent new equipment, or dispose of it at designated collection points. For more information see: www.recyclethis.info.



Directive 2006/66/EC and its amendment 2013/56/EU (Battery Directive): This product contains a battery that cannot be disposed of as unsorted municipal waste in the European Union. See the product documentation for specific battery information. The battery is marked with this symbol, which may include lettering to indicate cadmium (Cd), lead (Pb), or mercury (Hg). For proper recycling, return the battery to your supplier or to a designated collection point. For more information see: www.recyclethis.info.

1.DESCRPTION

The Hunt Series Thermal Clip-On featuring high thermal sensitivity ensures perfect detail recognition even in the hardest weather conditions when the object and background are with minimal temperature difference. Except that, using Hunt series thermal clip-on includes several benefits over night hunting with traditional optics or even the night vision devices. Attaching the Hunt series to a day scope delivers the same level of comforts of shooting with the day scope you are accustomed to, including your existing reticle and eye relief. The Hunt series thermal clip-on even allows you to continue utilizing variable magnifications of your day scope.

2.FEATURES

HUNT335



HUNT650

- Quick mounting and removal of attachment;
- 12 μ m thermal imaging detector, NETD \leq 20mk;
- 1024*768 resolution with 0.39-inch OLED display;
- No re-zeroing required and quick attachment to day optics;
- Magnesium alloy housing;
- Lightweight and compact design;
- Wireless remote control;
- Automatic object detection and distance measurement;
- APP connection via Wi-Fi supported;
- Various pseudo colors and target outline mode;
- Audio and recoil-activated video supported;
- Combination of shutter correction and shutterless technology;
- Up to 7h continuous working for lithium battery;
- IP67 rated protection;

3.SPECIFICATIONS

Model	Hunt335	Hunt650
-------	---------	---------

Microbolometer

Type	Uncooled	
Resolution	384x288	640x512
Pixel pitch	12µm	
NETD	≤20mk	
Spectral range	8-14µm	
Frame rate	50HZ	
Detection range	1,800m	2,600m

Optics

Objective lens	35mm	50mm
Field of view	7.5°x5.7°	8.8°x 7.0°
Recommended magnification of the day scope	1-8X	1-10X
Digital zoom	X1	

Display

Type	AMOLED
Resolution, pixel	1024x768
Display size	0.39 inch

Function

Max. recoil power on rifled weapon	6,000J
------------------------------------	--------

Image correction	Via shutter
USB interface	Type-C

Video Recorder

Photo/video playback	Yes
Built-in memory	64GB

Interface

Type C	Data transfer, battery charging
Wi-Fi	Yes
Bluetooth	Yes, Remote control

Battery

Built-in battery	7h	6h
------------------	----	----

Environment

Body material	Magnesium alloy	
Connection thread	M52×0.75	
Operating temperature	-20- +50°C	
IP rating	IP67	
Weight, g	400	
Dimension, mm	125(L)x65(W)x77(H)	129(L)x70(W)x77(H)

Notes:

1. The actual operating time depends on the intensity of using Wi-Fi, video recorder, and AI rangefinder.
2. Improvements may be made to the design and software of this product to enhance its useful features. The specifications of the device may be improved without prior notice.

4.PACKING LIST



Hunt clip-on (x1)



Remote control (x1)



USB cable (x1)

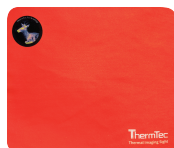

Lens cloth (x1)



User manual (x1)





5. COMPONENTS AND CONTROLS





5.1 Appearance of Hunt

1. Eyepiece
2. M52*0.75 connection thread
3. Eyepiece bayonet-type ring
4. OLED Brightness adjustment / OSD / AI rangefinder / Down button
5. Capture/Record/Menu button
6. pseudo color switch / Target outline mode / UI zooming / Up button
7. Lens focus knob
8. Lens cover
9. Objective lens
10. Power/Image correction button
11. Type-C port





















5.2 Description of Controls

Before entering the main menu			
Icon	Short press	Press and hold-on	Double click
	Standby mode / Wake up device	Power on/off	Image correction
	Capture	Record	Enter main menu
	Switch pseudo colors	Target outline mode	UI zooming
	OLED brightness adjustment	OSD on/off	AI rangefinder on/off

After entering the main menu			
Icon	Short press	Press and hold-on	Double click
	Standby mode / Wake up device	Power on/off	Image correction
	Confirm	Exit	N/A
	Up	N/A	N/A
	Down	N/A	N/A

5.3 Menu/Status Bar Icons

	Image set
	Battery power
	Zero profile
	Zeroing
	Hotspot/Bluetooth
	File
	Blind Pixel
	OLED
	Recoil-Activated Video (RAV)

	Time and Date
	Language
	Correction
	System Setting
	Hotspot Indicator
	AI Rangefinder
	Remote Control
	Image Capturing/Video Recording
	MIC

6.OPERATION GUIDE

WARNINGS

The Hunt series has been designed for long-term use. To ensure sustainable performance, please adhere to the following:

- Before use make sure that you have mounted and adjusted the device according to the section “**Operation Guide**”.
- Store with the lens cap on in the carrying case.
- Switch off the device after use.

Attempts to disassemble or repair the device will void the warranty!

- The device is designed for use in various operating temperatures. However, if it has been brought indoors from cold temperatures, do not turn it on for 2 to 3 hours. This will prevent external optical surfaces from condensation.
- To ensure reliable performance, it is recommended to carry out regular technical inspections of the device.

6.1 Installation

Hunt as an attachment is designed to use both in the nighttime and daytime under inclement weather (fog, smog, rain, etc.).

To mount it on a day scope, please follow the below instructions:

- Please make sure that the day scope is zeroed before installation.
- Measure the outer diameter of the lens of your day scope.
- Select an appropriate adapter with the internal thread M52*0.75 and an insert of the required diameter depending on the outer diameter of your day scope’s objective lens.
- Install the insert into the adapter all the way in.
- Install firmly the adapter with the insert onto the objective lens of your day scope.
- Check that the adapter firmly fits the objective lens.

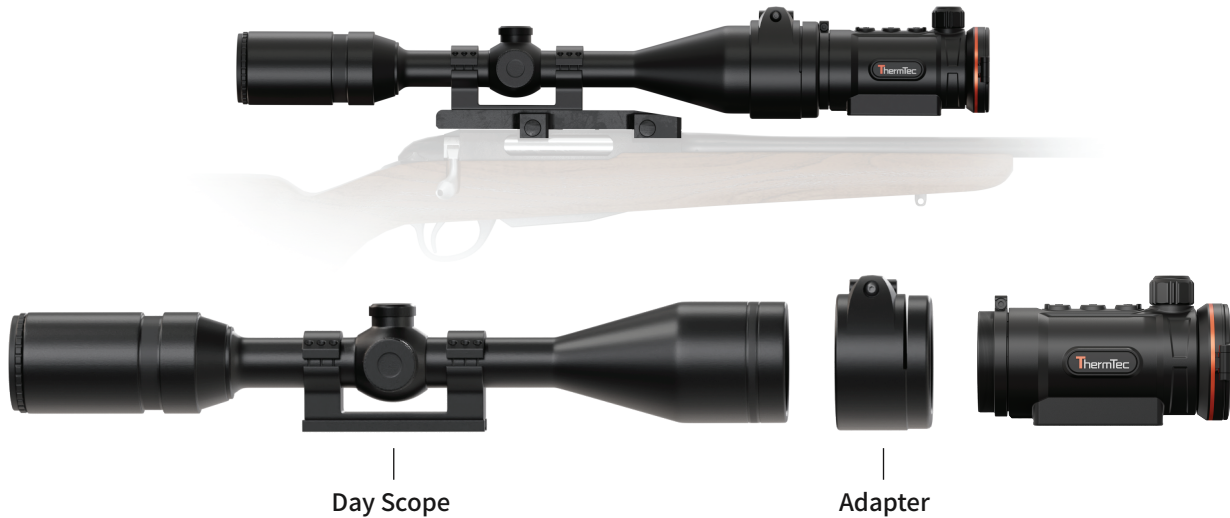

- If you see there is a clearance, please:
 - Loosen the locking screw with the hex-nut wrench (which depends on the adapter you used).
 - Tighten the screw with hex-nut wrench with a clamping force necessary to ensure that the adapter fits tightly the objective lens.
 - Tighten the locking screw.
- Mount the Hunt onto the adapter, and tighten the eyepiece bayonet-type ring counter clockwise to lock Hunt.
- After installation, if the center of Hunt's display is not aligned with the center of your day scope:
 - Loosen the locking screw with the hex-nut wrench.

6.2 Power On/Off

Long press the power button  for 3s to power on/off the Hunt.

6.3 Image Correction

Double click the power button  for image correction. Please refer to the “Correction” section for detailed guidance of image correction.

6.4 Standby Mode

Short press the power button  to standby the device for power saving, and press the power button  again to wake it up.



6.5 Lens Focus Adjustment

Open the lens cover, rotate the lens focus knob to focus on the object being observed.

6.6 Pseudo Color Switch

Short press  to change the pseudo colors. There are totally six pseudo colors (white hot, black hot, red hot, green, golden, violet) for user choice.



White



Black

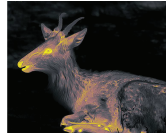

Golden



Red



Green



Violet

6.7 Target Outline Mode

Long press  to turn on/off the Target Outline Mode.



6.8 UI Zooming

Double click  to zoom in/out the UI icons to be well suited to the variable magnifications of your day optics.





6.9 AI Rangefinder

AI rangefinder function is used to check the distance of the target. Double click  to turn on/off the AI rangefinder function. You will see distance information on the display after activating this function.



6.10 OLED Brightness Adjustment

Short press  to adjust the OLED brightness level to make the image brighter or dimmer. There are 1-5 brightness levels for selection.

6.11 OSD Function

Long press  to turn on/off the OSD function. Video recording includes the menu on the screen after turning on the OSD function.

7.MAIN MENU

- On the home screen, double click the menu button “M” to enter the main menu interface.
- In the main menu, short press the “+ / -” button to switch the menu options.
- Short press the menu button “M” to adjust the parameters of present option.
- Press and hold the down menu button “M” for 3 seconds to exit to the home screen.
- Short press the Menu button “M” to save.

Main Menu function descriptions

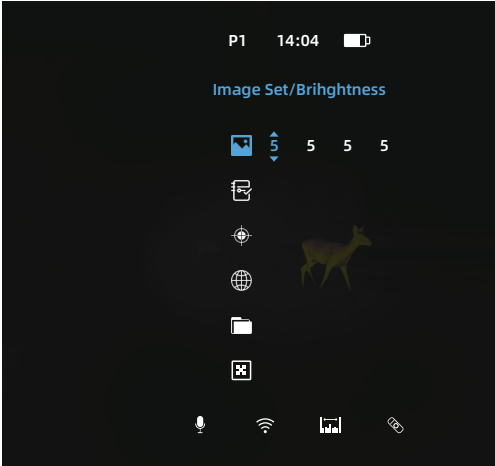
<p>Image Set</p> 		<h3>Turn Image set on/off</h3> <ul style="list-style-type: none">● Double click the menu button “M” to enter the main menu.● Select the Image Set option with the “+ / -” button. Short press the menu button “M” to enter Image Set.● The icon will be turned into blue when Image set is selected.● Set the parameters including Sharpness, Contrast, Brightness and Denoise as needed. These parameters are ranged from 1-10.
--	---	--

Zero Profile

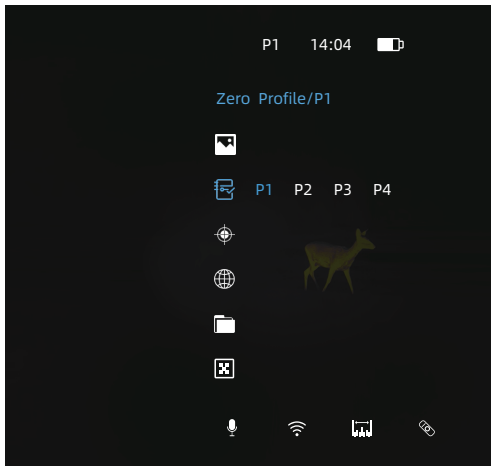

Select the Zero Profile

- Double click the menu button “M” to enter the main menu.
- Select the **Zero Profile** option with the “+ / -” button. Short press menu button “M” to enter **Zero Profile**.
- The icon will be turned into blue when **Zero Profile** is selected.
- There are four profile options: P1/P2/P3/P4. It will show at the top of the screen when a certain **Zero Profile** is selected.
- Short press the menu button “M” to confirm the selection of one profile.

Zeroing



Zeroing

- Double click the menu button “M” to enter the main menu.
- Select the **Zeroing** option with the “+ / -” button. Short press menu button “M” to enter **Zeroing**.
- The icon will be turned into blue when **Zero Profile** is selected.
- Please refer to the **ZEROING** section for detailed guidance for zeroing.

Hotspot / Bluetooth

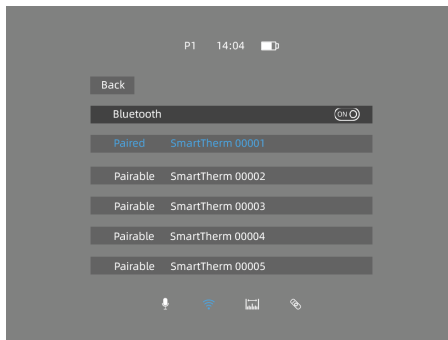
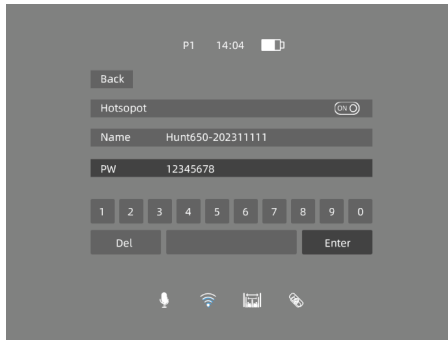

Turn Hotspot function on/off

- Double click the menu button “M” to enter the main menu.
- Select the **Hotspot** option with the “+ / -” button. Short press menu button “M” to enter **Hotspot** Settings.
- The icon will be turned into blue when **Hotspot** is selected.
- When **Hotspot** is on, it can be connected with “ThermTec Outdoor” APP. The default password is 12345678.

Turn the Bluetooth on/off

- Connecting with Bluetooth is also available here.
- After connecting, the device could be controlled via “ThermTec Outdoor” APP.

File

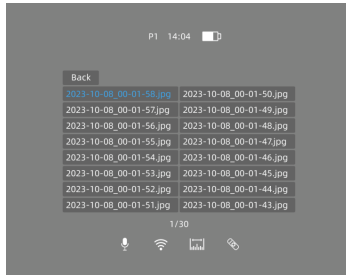
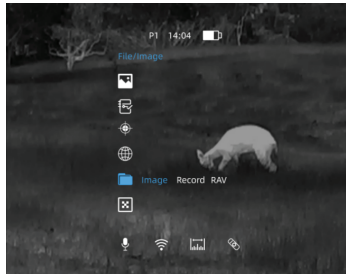

Check the Captured Images

- Double click the menu button **M** to enter the main menu.
- Select the **File** option with the + / - button. Short press menu button **M** to enter **File**.
- The icon will be turned into blue when **File** is selected.
- Click **M** to enter image files.
- After selecting a certain image, click **M** to access further operation of the image. You may delete it, check next one or delete all the images.

File

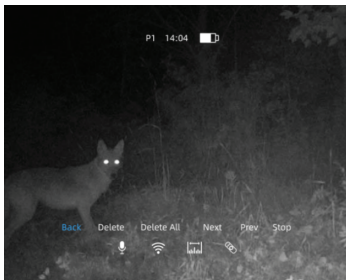
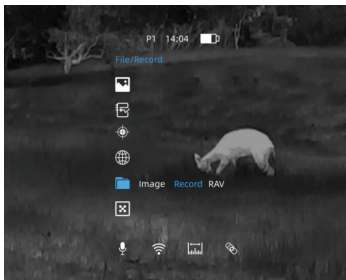

Check the Recorded Videos/RAV Videos

- Double click the menu button **M** to enter the main menu.
- Select the **File** option with the + / - button. Short press menu button **M** to enter **File**.
- The icon will be turned into blue when **File** is selected.
- Select Record/RAV and click M to enter Video/RAV Files.
- Choose a certain video and press **M** to check the video.
- Further operation could be accessed here. You may delete it, check next one, pause it or delete all the videos.

Blind Pixel

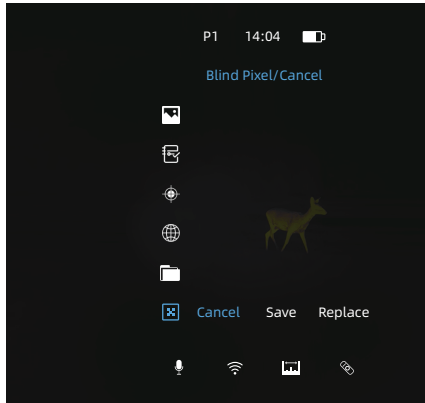

Turn Blind Pixel function on/off

- Double click the menu button “M” to enter the main menu.
- Select the **Blind Pixel** option with the “+ / -” button. Short press menu button “M” to enter **Blind Pixel**.
- The icon will be turned into blue when **Blind Pixel** is selected.
- Select the blind pixel and confirm the selection of Cancel, Save or Replace.

OLED

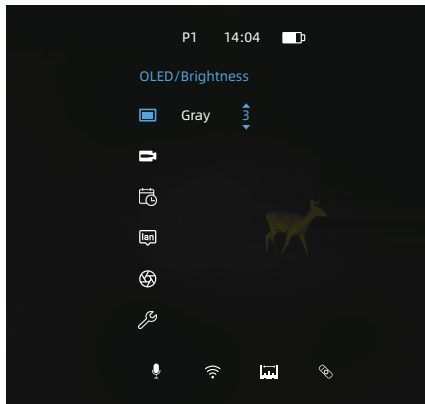

Set OLED

- Double click the menu button “M” to enter the main menu.
- Select the **OLED** option with the “+ / -” button.
- Short press menu button “M” to enter **OLED**.
- The icon will be turned into blue when **OLED** is selected.
- Confirm OLED color and brightness level.
- There are 4 palettes optional: Grey, Blue, Purple and Red.
- Short press the Menu button “M” to exit, or press and hold the “M” to exit.

RAV

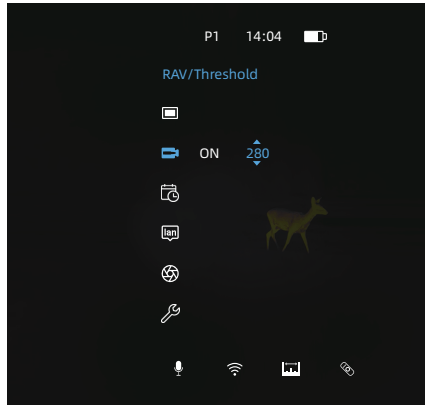

Turn RAV function on/off

- Double click the Menu button “M” to enter the main menu.
- Select the **RAV** option with the “+ / -” button. Short press menu button “M” to enter **RAV**.
- The icon will be turned into blue when **RAV** is selected.
- You can set whether to enable the RAV function or set the trigger threshold for RAV. The recommended value is 280.

Time

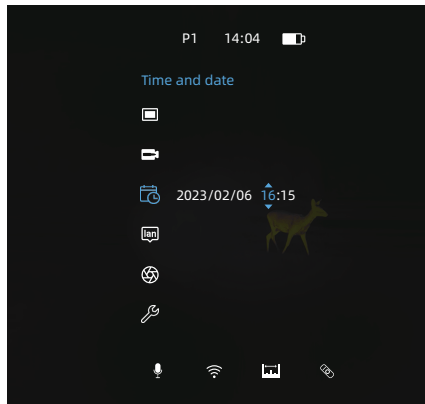

Set Time

- Double click the menu button “M” to enter the main menu.
- Select the **Time** option with the “+ / -” button.
- Short press menu button “M” to enter **Time**.
- The icon will be turned into blue when **Time** is selected.
- After entering the time setting page, you can set a specific time.
- Short press the menu button “M” to exit, or press and hold the “M” to exit.

Date

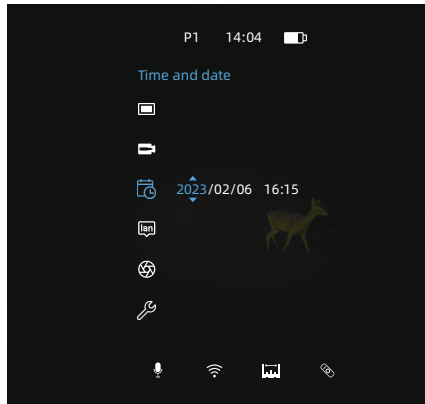

Set Date

- Double click the menu button “M” to enter the main menu.
- Select the **Date** option with the “+ / -” button. Short press menu button “M” to enter **Date**.
- The icon will be turned into blue when **Date** is selected.
- After entering the date setting page, you can set a specific date.
- Short press the menu button “M” to exit, or press and hold the “M” to exit.

Language

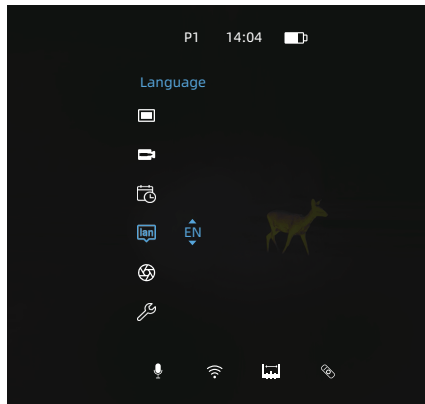

Set Language

- Double click the menu button “M” to enter the main menu.
- Select the **Language** option with the “+ / -” button. Short press menu button “M” to enter **Language**.
- The icon will be turned into blue when **Language** is selected.
- Multiple languages can be selected, including English, Germany, Spain, etc.
- Short press the menu button “M” to exit, or press and hold the “M” to exit.

Correction

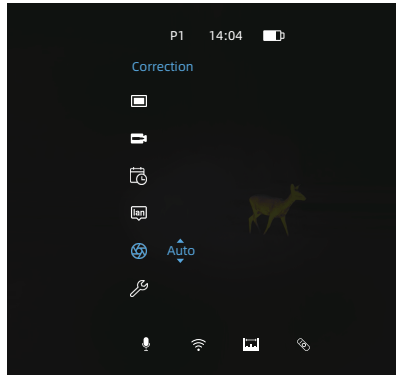

Turn Correction on/off

- Double click the menu button “M” to enter the main menu.
- Select the Correction option with the “+ / -” button. Short press menu button “M” to enter Correction.
- The icon will be turned into blue when Correction is selected.
- Choose Auto or Manual to enter the mode of auto correction or manual correction respectively.
- Under auto correction mode, the image would be calibrated automatically as per the actual conditions. It would count down from 5s every time when the image is under auto correction. The screen would freeze when the image is under correction.
- Short press the menu button “M” to exit, or press and hold the “M” to exit.

System

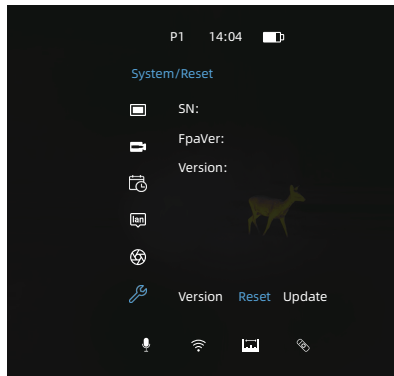

System setting

- Double click the menu button “M” to enter the main menu.
- Select the **System** option with the “+ / -” button. Short press menu button “M” to enter **System**.
- The icon will be turned into blue when **System** is selected.
- After entering the system settings, you can choose to reset or upgrade. Information like firmware version, serial number and other relevant information could be checked on the reset page.
- It only supports upgrading via PC on this page.
- Short press the Menu button “M” to confirm current settings, or press and hold the “M” to exit.

8.ZEROING

When the Hunt is installed on the day scope properly, if the reticle of the day scope is not at the center of the infrared image, the image zeroing function can be used to shift the infrared image to ensure the position consistency between the day scope image and the infrared image.

- Please finish the correction of the day scope before mounting the Hunt.
- Install the Hunt on the day scope referring to the **Installation** section.
- Aiming at the 100m target and shoot.
- On the home screen, double click Menu button “M” to enter the main menu interface.

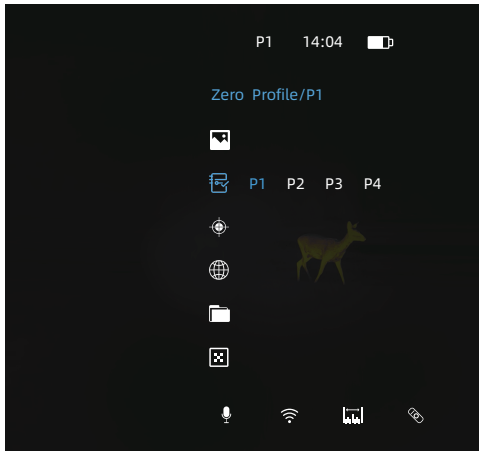

- Press the “+ / -” button to move the cursor up or down, and select the Zero Profile option and choose a **zero profile** with a short press of the menu button “M”.

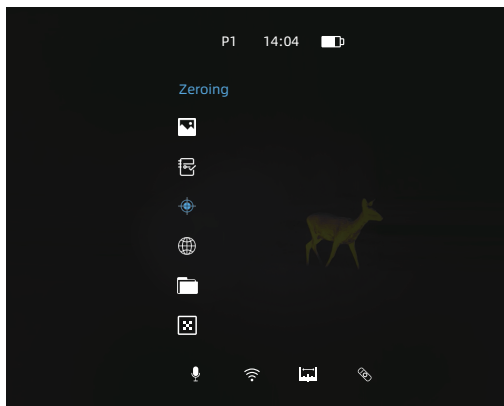

- Select the Zeroing option and short press the Menu button “M” to enter the zeroing interface.

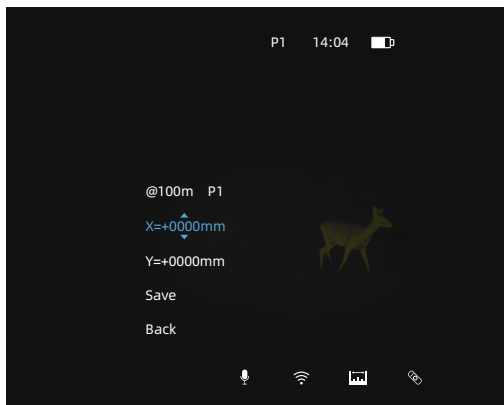

- At the zeroing interface, short press the “+ / -” button to move the position of infrared image until the target observed by the combined thermal imaging and white light sight coincides with the target observed by the white light sight alone, with a default zero distance of 100 meters.

- When entering the zero settings, short press the menu button “M” to confirm the set parameters and exit the page turning, or press and hold menu button “M” to exit the page and restore to the default settings.

9.CAPTURING AND RECORDING

There is built-in 64GB storage space set for image capturing and video recording. The files of images and videos will be named by time, so it is recommended to set the time in the main menu or synchronize the time in the settings of “ThermTec Outdoor” APP before using the image capturing and video recording function.

Image Capturing

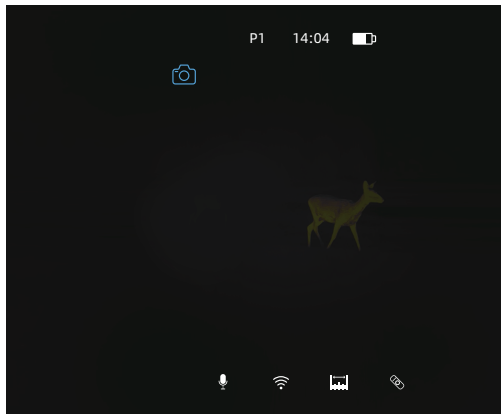

- Press the camera button “M” to take a photo and a capture icon appears on the screen.

- Images are saved in the built-in storage space.

Video recording

- Press and hold down the camera button “M” to start a video recording.

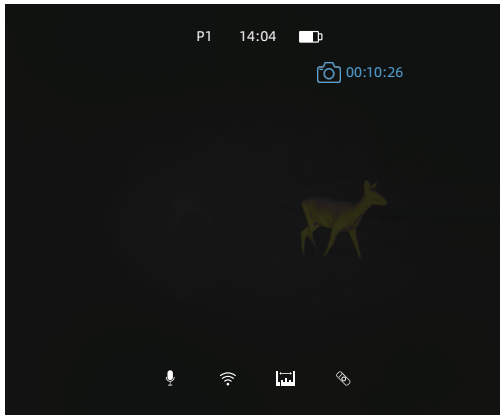

- A recording timer displays on the top of the screen. The time format is HH:MM:SS (Hour:Minute:Second).

- You may enter the menu and enable other functions during video recording.
- Press and hold down the camera button “M” to stop and save the recording.
- The videos are saved in the built-in storage space.

Caution:

- The number of the recorded files is limited by the capacity of the internal memory.
- Check the available space of the built-in storage card regularly and move the footage to other storage media to free up the memory card space.

10.MEMORY ACCESS

When the device is turned on and connected to a computer, it is recognized by the computer as a flash memory card, which is used to access the device's memory and make copies of pictures and videos.

- Turn on the Hunt and connect it with the computer via Type-C cable.
- Double click and open the folder named '1024' to access images and videos.
- Images and videos are saved separately in the folders of "Capture" and "Record".
- There are different images and videos named by time in the storage.
- Select desired files or folders to copy or delete.

11.HOTSPOT FUNCTION

A built-in hotspot module is integrated in the Hunt, which enables the device to connect wirelessly to external devices such as smart phones.

- Double click Menu button "M" to enter the main menu.

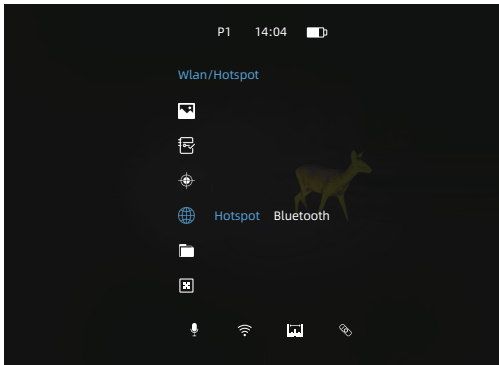

- Turn Hotspot function on /off with a short press of menu button “M”.

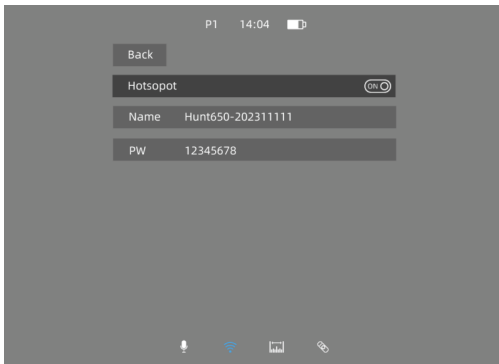

- Turn on “ThermTec Outdoor” APP, select Wi-Fi, and type in the password on the mobile device to finish the connection. The initial password is 12345678.

- When Wi-Fi is successfully connected, you can control the device via “ThermTec Outdoor” APP.

Set the Hotspot name and password

The Hunt series allows users to change the name and password of device hotspot in the Hotspot settings.

12.REMOTE CONTROL

Hunt series, which takes no attachment over device's surface, boasts of eminent ring-control design to better operate the device itself. It could connect the device via Bluetooth.

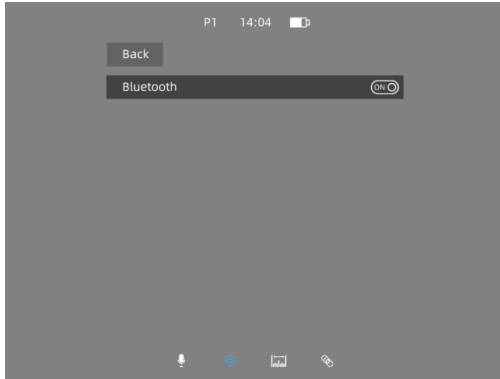

- Turn on the Bluetooth of your device.



- Open the battery case of the remote and await it detecting around to check the Bluetooth of your device.

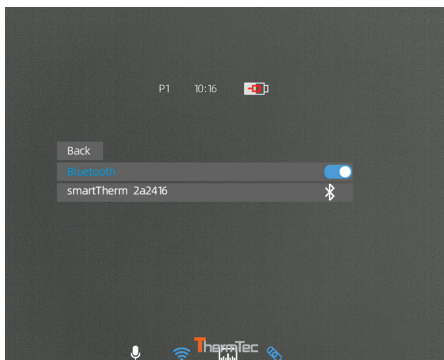

- After connection, you can control the Hunt remotely.

- The remote control can be used continuously for more than 10 hours in one time and it could reach almost 48 hours with the charging case.
- If the battery runs out, you may charge it directly through the charging case, or charge the battery case and put the remote control into it to charge them at the same time.
- Once the device connects with one remote control, it wouldn't display or connect with other remote controls. Please unlock the pairing by pressing the M button for 10s before connecting with another remote control.

13.DOWNLOAD “ThermTec Outdoor” APP

You may download the “ThermTec Outdoor” APP through the QR code shown on the packing box, user manual or below.



14. TECHNICAL INSPECTION

A technical inspection of the device is recommended before use.

- Check the external appearance of the device (there should be no cracks in the casing).
- Check the condition of the lens and eyepiece (there should be no cracks, greasy spots, dirt or other deposits).

15. MAINTENANCE

Maintenance should be carried out at least twice a year and consist of the following actions.

- Wipe the external surfaces of metal and plastic parts free of dust and dirt with a cotton cloth. Silicone grease maybe used for this.
- Check the glass surfaces of the eyepiece and the lens. If necessary, remove dust and sand from the lenses (preferably using a non-contact method). Cleaning of the external surfaces of the optics should be done with substances designed especially for this purpose.

16. FIRMWARE UPGRADE

Hunt series thermal clip-on is supported by the “ThermTec Outdoor” APP, which allows you to transmit the images and videos from the device to the smartphone or tablet via Hotspot in real time.

The electronic version of this User Manual and the latest firmware can be downloaded from the ThermTec website: www.thermeyetec.com. Firmware upgrade can also be finished via the “ThermTec Outdoor” APP.

Upgrading via APP

- Open ThermTec Outdoor APP.

- If your device is already connected with mobile device, please turn off the mobile network. After connection, the window will automatically prompt in the middle of the screen about all the available firmware versions.
- Select the corresponding package and download.
- Please pre-download before connection due to the process needs internet to get data.
- After finishing the update, the device will reboot.
- Instructions for detailed upgradation can also be downloaded from the official website.

Upgrading via PC

- Please download corresponding upgrading package from official website. www.thermeyer.com.



- Connect the device to PC via Type-c data cable.

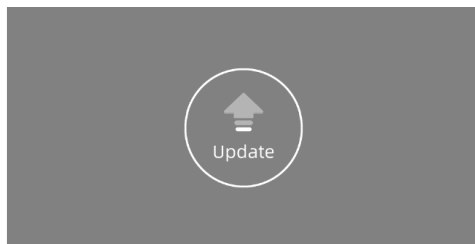

- Copy the related updating firmware to the file folder of Hunt. Press “M” to select Update icon, and the system will prompt “Update”.

- Enter Reset menu to check firmware version.



ThermTec Technology Co., Ltd.
Email: info@thermeyetec.com
Web: www.thermeyetec.com



COPYRIGHT © 2023 ThermTec Technology Co., Ltd. ALL RIGHTS RESERVED.