

ThermTec

Vidar Series
Thermal Imaging

Thermal Imaging Scope Vidar Series User Manual



Model No.:

Vidar335/Vidar350/Vidar360/Vidar635/Vidar650/Vidar660
Vidar335L/Vidar350L/Vidar360L/Vidar635L/Vidar650L/Vidar660L



IOS



Andriod

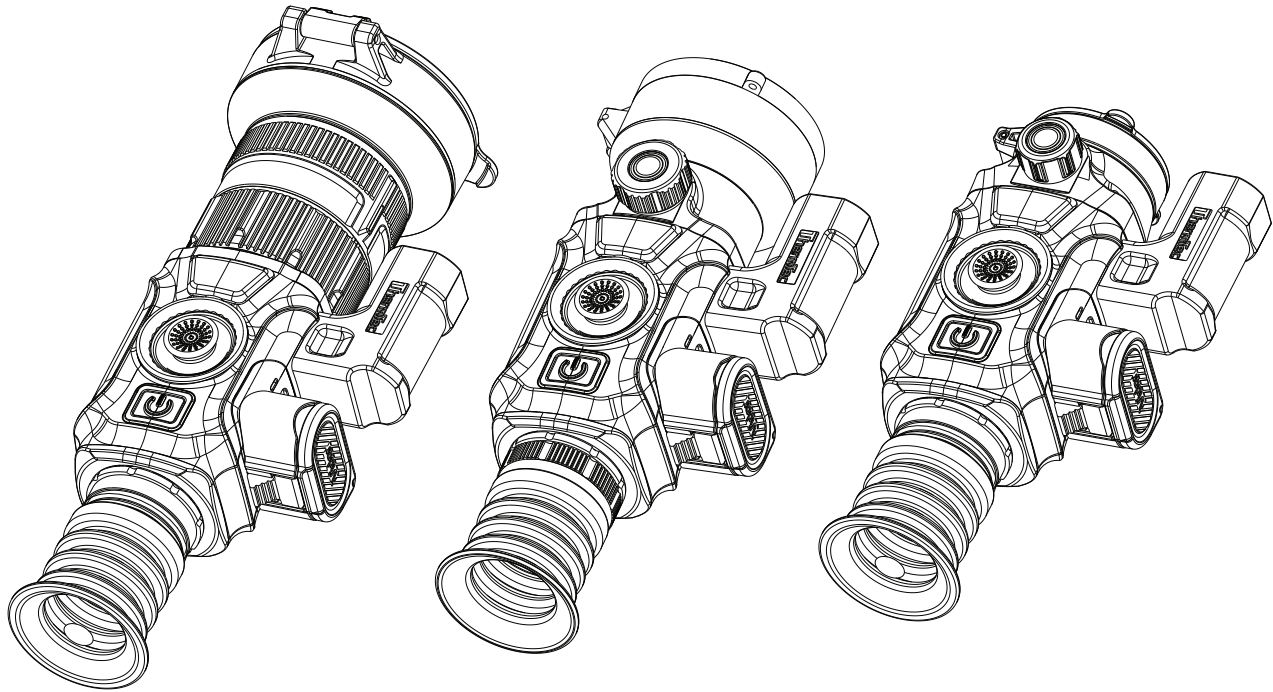

SONY



Table of Contents

Important Safety Information	5	9. Digital Zoom	20
1. Introduction	8	10. Status Bar	21
2. Features	8	11. Memory Access	21
3. Specifications	9	12. Main Menu	21
4. Packing List	11	13. Reticle	29
5. Appearance of Vidar	13	13.1 Type	29
6. Buttons and Controls	15	13.2 Dot	29
7. Installation Guide	16	13.3 Location	30
7.1 Battery Installation	16	13.4 Brightness	31
7.2 Picatinny Rail Installation	16	13.5 Mode	31
8. Operation Guide	17	14. PIP (Picture in Picture)	31
8.1 Power-on the Device	17	15. Download “Smart Thermal” APP	32
8.2 Image Calibration (with Lens Cover Closed)	17	16. Technical Inspection	32
8.3 Pseudo Color Switch	18	17. Maintenance	32
8.4 Target Outline Mode	18	18. Update and ThermTec Outdoor	32
8.5 Turning off the Device	18	Information to the User	34
8.6 Standby Mode	19		
8.7 Diopter Adjustment	19		
8.8 Objective Lens Focusing	19		
8.9 FOV Selection and Shift	19		

IMPORTANT SAFETY INFORMATION

Environmental influences

WARNING! Prohibition that the lens of the device immediately look towards at intense heat such as the sun or laser device. The objective lens and eyepiece can have an influence on a burning glass and damage the internal components, the guarantee can not include damage caused via an incorrect operation.

Safety instructions for use

- Handle the device and battery pack with care: rough handling may damage the battery pack.
- Do not expose the device to fire or high temperatures.
- Only use the battery charger included in the delivery package.
- The battery capacity decreases when operated in a cold ambient temperature. This is not a fault and occurs for technical reasons.
- Always store the device in its carrying bag in a dry, well-ventilated space. For prolonged storage, remove the batteries.
- Do not expose your device to extreme temperatures lower than - 20°C and higher than + 50°C.
- The product shall only be connected to a USB Type C interface.
- If the device has been damaged or the battery is defective, send the device to our after-sales service for repair.

Safety instructions for the power supply

- Check the power supply unit, cable and adapter for visible damage before use.
- Do not use any defective parts. Defective components must be replaced.
- Do not use the power supply unit in wet or humid environments.
- Only use the original cable provided with the battery charger.
- Do not make any technical modifications.

For further information and safety instructions, please refer to the User Manual provided. It is also available on our website in the download center: www.thermeyer.com.

Regulatory information



This product and - if applicable - the supplied accessories too are marked with "CE" and comply therefore with the applicable harmonized European standards listed under the Directive 2014/53/EU (RED), Directive 2014/30/EU (EMC), Directive 2014/35/EU (LVD), Directive 2011/65/EU (RoHS).



This product and - if applicable - the supplied accessories too are marked with “UKCA” and comply therefore with the following directives: Radio Equipment Regulations 2017, Electromagnetic Compatibility Regulations 2016, Electrical Equipment (Safety) Regulations 2016, the Restriction of the Use of Certain Hazardous Substances in Electrical and Electronic Equipment Regulations 2012.

 This product and - if applicable - the supplied accessories too are marked with “RoHS” and comply therefore the requirements of Directive 2011/65/EU on the restriction of the use of certain hazardous substances in electrical and electronic equipment (“RoHS recast” or “RoHS 2”).

2012/19/EU (WEEE directive): Products marked with this symbol cannot be disposed of as unsorted municipal waste in the European Union. For proper recycling, return this product to your local supplier upon the purchase of equivalent new equipment, or dispose of it at designated collection points. For more information see: www.recycle-this.info.



Directive 2006/66/EC and its amendment 2013/56/EU (Battery Directive): This product contains a battery that cannot be disposed of as unsorted municipal waste in the European Union. See the product documentation for specific battery information. The battery is marked with this symbol, which may include lettering to indicate cadmium (Cd), lead (Pb), or mercury (Hg). For proper recycling, return the battery to your supplier or to a designated collection point. For more information see: www.recyclethis.info.

For business customers within the European Union

Please contact your dealer or supplier regarding the disposal of electrical and electronic devices who will provide you with further information.

Information on disposal in other countries outside of the European Union

This symbol is only applicable in the European Union. Please contact your local authority or dealer if you wish to dispose of this product and ask for a disposal option.

Intended user

The device is intended for displaying heat signatures during nature observation, remote hunting observations and for civil use. This device is not a toy for children.

Use the device only as described in this User Manual. The manufacturer and the dealer accept no liability for damages which arise due to non-intended or incorrect use.

Installing/removing the battery

The vidar series thermal imaging scope is equipped with two power supply systems – one built-in battery pack and the other replaceable 18650 battery. The built-in battery pack cannot be removed.

CAUTION



CAUTION



Avoid hard objects.



Do not aim the lens directly at the sun or high-temperature light sources.



Do not use the device in extremely cold or hot environment.



Charge the battery once every three months when it is not used for a long period of time.



Do not irradiate the laser indicator of the device to human eyes.



Do not disassemble or modify the device by yourself in any way.

1 Introduction

Compact Vidar Series thermal imaging scope is equipped with 12µm high-sensitivity detector with the resolution up to 640x512, and adopts various focal lengths, 1024x768 high-definition OLED display, as well as Laser rangefinder activation, up to 1,200m for measurement distance. It gets clear view under harsh environments, even in poor visibility or total darkness. It helps to see through obstacles hindering the detection of targets. The function of easy connection to phone enables users to share views in real time.

Vidar Series thermal imaging scope is designed for various areas of application including night hunting, observation, rescue operations, hiking and traveling, etc.

2 Features

- ◆ Dual FOV
- ◆ Ballistic calculator
- ◆ Auto zeroing
- ◆ Laser rangefinder up to 1,200m
- ◆ Memory chip up to 64GB
- ◆ Compact design
- ◆ Shutterless technique
- ◆ Automatic object detection
- ◆ Easy battery installation
- ◆ Picture in picture function
- ◆ 1x--5x continuous zoom
- ◆ Support RAV function
- ◆ Various pseudo colors
- ◆ Polarity reversal for crosshairs

3 Specification - Vidar 3/6

Model	Vidar335	Vidar350	Vidar360	Vidar635	Vidar650	Vidar660
Microbolometer						
Type	Uncooled					
Resolution	384x288		640x512			
Pixel pitch	12µm					
NETD	≤25mk					
Spectral range	8-14µm					
Frame rate	50HZ					
Optics						
Objective lens	35mm, F1.0	50mm, F1.0	20/60mm, F1.0	35mm, F1.0	50mm, F1.0	20/60mm, F1.0
Field of view	7.5°x5.6°	5.3°x4.0°	13.1°x9.8° / 4.4°x3.3°	12.5°x10.0°	8.8°x7.0°	21.7°x17.4° / 7.3°x5.9°
Magnification	3.2X	4.6X	1.8X/5.5 X	1.9X	2.7X	1.1X/3.2 X
Digital zoom	1.0-5.0X smooth & rapid zoom					
Eye relief	45mm					
Exit pupil	6mm					
Diopter	±5D					
Aiming Reticle						
Click range, mm @100 m (H/V)	3.6m/3.6m					
Reticle	7					
Rectile color	Black and white					
Display						
Type	AMOLED					
Resolution	1024x768					
Display size	0.39 inch					
Color palette	6					

Function						
Max. recoil power on rifled weapon	6,000J					
Mounting brackets on weapon	Standard Picatinny Rail					
RAV	Yes					
Auto zeroing	Yes					
Manual zeroing	Yes					
Zeroing profiles	5					
Picture-in-picture	Yes					
Image calibration	Via lens cover					
Video Recorder						
Photo/video playback	Yes					
Built-in memory	64GB					
Interface						
Magnetic interface	Data transfer					
Wi-Fi	Yes					
Battery						
Replaceable battery	18650x2					
Battery reverse connection	Yes					
Battery life	14h		13h			
Environment						
Operating temperature	-20°C—+50°C					
IP rating	IP67					
Weight, g	591	646	880	591	646	880
Dimension, mm	160x60x70	204x72x91	220x84x87	160x60x70	204x72x91	220x84x87
Accessories						
Magnetic cable	Magnetic interface data cable					
Other accessories	Standard Picatinny Rail, eyeshade, etc.					

Specification - Vidar 3L/6L

Model	Vidar335L	Vidar350L	Vidar360L	Vidar635L	Vidar650L	Vidar660L
Microbolometer						
Type	Uncooled					
Resolution	384x288			640x512		
Pixel pitch	12µm					
NETD	≤25mk					
Spectral range	8-14µm					
Frame rate	50HZ					
Optics						
Objective lens	35mm, F1.0	50mm, F1.0	20/60mm, F1.0	35mm, F1.0	50mm, F1.0	20/60mm, F1.0
Field of view	7.5°x5.6°	5.3°x4.0°	13.1°x9.8°/ 4.4°x3.3°	12.5°x10.0°	8.8°x7.0°	21.7°x17.4° / 7.3°x5.9°
Magnification	3.2X	4.6X	1.8X/5.5X	1.9X	2.7X	1.1X/3.2X
Digital zoom	1.0-5.0X smooth & rapid zoom					
Eye relief	45mm					
Exit pupil	6mm					
Diopter	±5D					
Aiming Reticle						
Click range, mm @100 m (H/V)	3.6m/3.6m					
Reticle	7					
Reticle color	Black and white					
Display						
Type	AMOLED					
Resolution	1024x768					
Display size	0.39 inch					
Color palette	6					

Function						
Max. recoil power on rifled weapon	6,000J					
Mounting brackets on weapon	Standard Picatinny Rail					
RAV	Yes					
Auto zeroing	Yes					
Manual zeroing	Yes					
Zeroing Profiles	5					
Picture-in-picture	Yes					
Laser rangefinder	1,200m					
Ballistic calculator	Yes					
Image calibration	Via lens cover					
Video Recorder						
Photo/video playback	Yes					
Built-in memory	64GB					
Interface						
Magnetic interface	Data Transfer					
Wi-Fi	Yes					
Battery						
Replaceable battery	18650x2					
Battery reverse connection	Yes					
Battery life	11h			10h		
Environment						
Operating temperature	-20°C—+50°C					
IP rating	IP67					
Weight, g	631	686	920	631	686	920
Dimension, mm	160x90x70	204x72x102	220x100x87	160x90x70	204x72x102	220x100x87
Accessories						
Magnetic cable	Magnetic interface data cable					
Other accessories	Standard Picatinny Rail, eyeshade, etc.					

4 Packing list



Vidar scope
1pcs



Eyepiece hood
1pcs



Charger
1pcs



Picatinny rail
1pcs



Magnetic data
cable
1pcs



Lithium battery
4pcs



Allen key
1pcs
Small Allen key
1pcs



T2.9 Screw
3pcs



Lens Cloth
1pcs

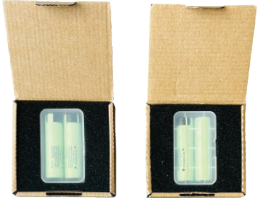
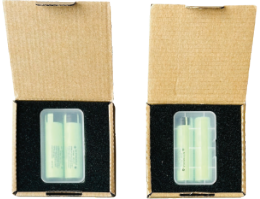

Appearance of Vidar

5.1 Single FOV

1. Laser ranging
2. Magnetic USB
3. 18650 battery with 2pcs
4. Battery box
5. Eyeshade
6. Diopter ring
7. Power button
8. Joystick
9. Lens focus knob
10. Lens cover

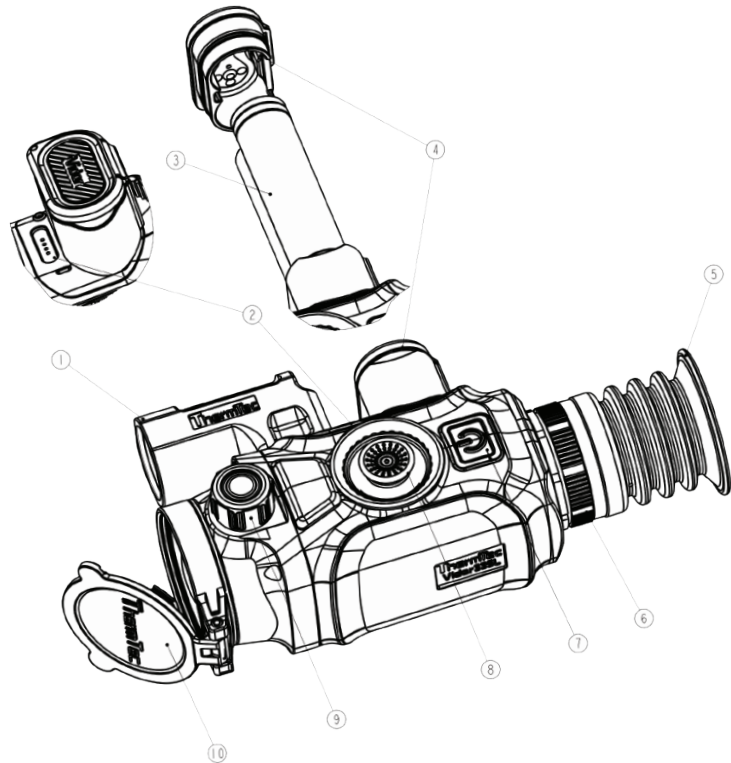

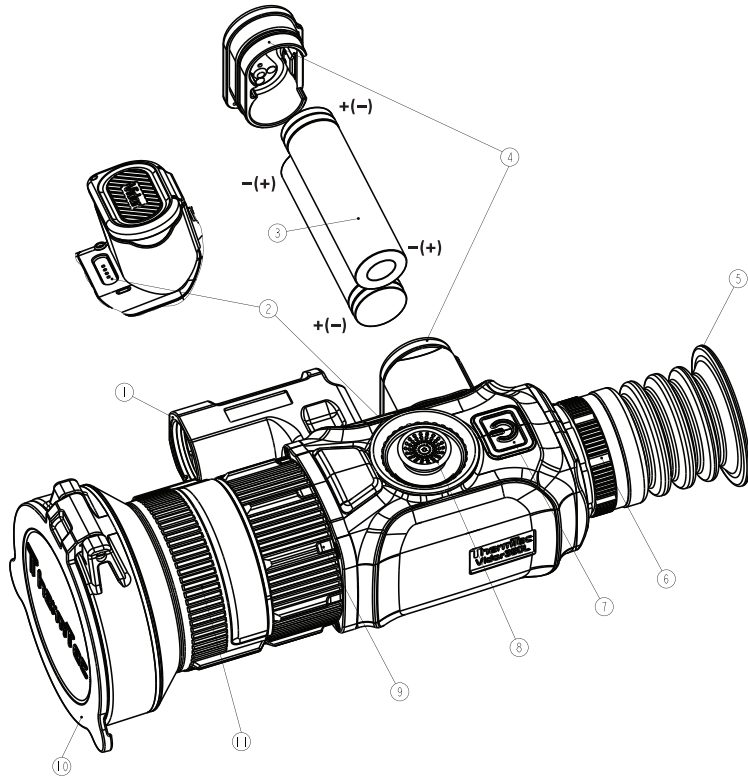

5.2 Dual FOV

- 1.Laser ranging
- 2.Magnetic USB
- 3.18650 battery with 2pcs
- 4.Battery box
- 5.Eyeshade
- 6.Diopter ring
- 7.Power button
- 8.Joystick
- 9..Lens focus knob
- 10.Lens cover
- 11.Dual FOV shift



Buttons and Controls

Power ON/OFF 	Short press	Enter standby mode and the screen is locked. It enters normal status when user short presses the joystick during the counting down within 3s.
	Long press	ON/OFF
	Before the Entry of Main Menu	
	Double press	Image calibration (with lens cover closed)

Joystick 	Before the Entry of Main Menu							
	Long press upward	Long press downward	Short press to the right	Long press to the right	Short press to the left	Double press	Press	Long press
	Zoom in	Zoom out	Pseudo color switch	Target Outline Mode	Ranging on/off	Main menu	Take photos	Take videos

Note: Please make sure the lens cover is closed and calibrate the image prior to powering on the device.

7 Installation Guide

7.1 Battery Installation

Install 2pcs of 18650 battery to the battery slot. Please make sure that one battery is installed with the positive pole outwards, while the other battery is installed with the negative pole outwards, as shown in the below pictures.



Open the battery cover

Press the battery cover first, and then press the buckle at the same time to open the cover.



Close the battery cover

Press the buckle first, and then press the battery cover at the same time to close the cover.



Notice: The battery icon would turn to red when the device is out of power, and the lithium battery has to be replaced for charging.

7.2 Picatinny Rail Installation

Take the picatinny rail and 3pcs of screws to fix bottom hole of Vidar into suitable position. Adjust the position of Vidar and the picatinny rail when installing on the weapon to ensure comfortable object observation.



Note: It is recommended to install Vidar as low as possible, and keep it away from the barrel. Screws must be fixed tightly when position adjustment is finished.

8 Operation Guide

8.1 Power-on the Device



Press power button (7) for a while till OLED display is powered on.



The screen after turning on the device

8.2 Image Calibration (with Lens Cover Closed)

Taking advantage of the non-shutter correction technology, this device supports consistent view for shooting. In case that the sensor performance or the image quality need to be recovered or optimized, please follow below steps for image calibration.

Exit the main screen first, and then short press the power button (7) twice.

- ① A prompt will appear on the screen, reminding you to close the lens cover during image calibration.
- ② Click "OK" to start the process after closing the lens cover.



Note: Please always keep the lens cover closed for image calibration before powering on the device.

8.3 Pseudo Color Switch

Short press the joystick (8) towards right for switching pseudo color each time. There are totally six pseudo colors (white hot, black hot, red hot, green, golden, violet) for user choice.



White hot

Black hot

Red hot



White hot

Black hot

Red hot

8.4 Target Outline Mode



Long press the joystick (8) towards right to turn on/off the Target Outline Mode.



Target Outline Mode

8.5 Turning off the Device



Press the power button (7) for 3 seconds for shutting down the device.

Note: The device would return to working state if re-pressing the power button for one more time during this process.

8.6 Standby Mode



Short press the power button (7) to enter the standby mode.

8.7 Diopter Adjustment

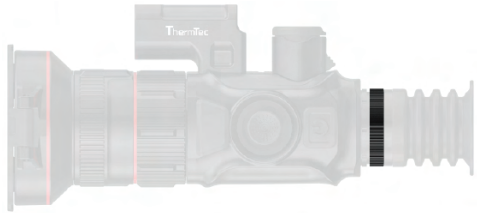

Rotate the diopter ring (6) slowly to adjust the position of diopter level and optimize the image sharpness on the OLED display.

8.8 Objective Lens Focusing



Adjust the objective lens focus knob (9) when necessary for defined image.

8.9 FOV Selection and Shift (for Vidar360(L)/660(L))

The device is set with dual - field of view . Rotate the lens to shift the field of view from 20° to 60° or from 60°to 20° (for Vidar 360(L)/660(L)) .

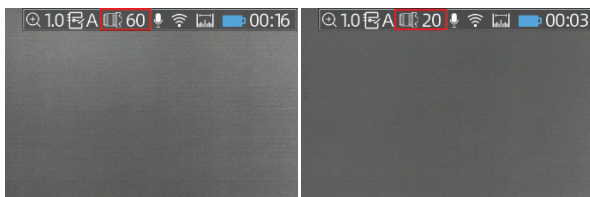

Shift the FOV from 60° to 20°

FOV successfully shifted

9 Digital Zoom

Vidar series support 1.0-5.0X continuously adjusted digital zoom function.



Press the joystick (8) to digitally adjust the focus distance. Press upward for zooming in, and press downward for zooming out.

Notice: Under the rapid zoom mode, Vidar can carry out integral digital zoom. Please refer to “Zoom Section” for details.

10 Status Bar

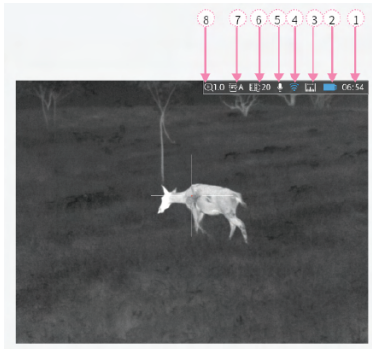

The status bar shows information about the device's current operations. In sequence, including as following:

1. Time (Setting method in the main menu).
2. State of battery (Reminder to charge the battery when the icon turns to red).
3. Laser rangefinder (The blue icon will show in the status bar when this function is enabled).
4. Wireless (Connection state if hot spot & WIFI would be set up or not).
5. Audio icon (Audio for video recording and RAV).
6. Focal length of objective lens (Vidar360/660 series support 20/60mm switching mutually with dual FOV).
7. Zeroing profile (Currently selected zeroing profile).
8. Current digital zoom (Rapid zoom for continuous 1.0-5.0X, default factor is 1.0X).

11 Memory Access

User can connect to computer when Vidar is turned on via magnetic charging wire, also it would be recognized via PC as a flash card. User can download photos or videos.

Notice:

- User can still operate other functions from the menu when video is recording.
- Photos and videos are stored in the memory chip of the main board of Vidar.
- The memory space is up to 64GB, so the number of files is limited by the capacity of the built-in memory space of the device. If photos or videos are taken frequently, it is important to check the available space of memory from time to time.

12 Main Menu

- ◆ Double press joystick (8) to go to the main menu.
- ◆ Press joystick (8) forward and backward to switch function options in the main menu.
- ◆ Short press the joystick (8) to modify the parameters of the current option or enter the sub-menus.
- ◆ When moving the cursor to select an icon, the color of the selected icon will change from gray to black.
- ◆ Press and hold the joystick (8) to save the current change, and press the joystick (8) toward left one time to go back to the main menu.

Main Menu Features and Direction

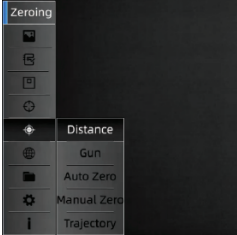
Image	Brightness	Adjust the image brightness to make the image brighter or dimmer. The highest value is 10, and the default value is 5.
	Sharpness	Adjust the image sharpness to make the edges of image sharper. The highest value is 10, and the default value is 5.
	Denoise	Adjust the image denoise to make the image cleaner. The highest value is 10, and the default value is 5.
	Contrast	Adjust the image contrast to make the image more prominently. The highest value is 10, and the default value is 5.
Zeroing Profile	 <p>Choice the zeroing profile There are five zeroing profiles from “A-E” in the file, which contain the distance, type of gun, and the coordinates of the crosshairs after zeroing.</p> <ul style="list-style-type: none"> ● Double press the joystick (8) to enter main menu. ● Press the joystick (8) to select the profile option under the submenu. ● Press the joystick (8) forward or backward to select the corresponding profile from the total five options from A to E. ● The selected zeroing profile will appear at the top right corner of the status bar. 	
Zeroing	 <p>Setting zeroing</p> <ul style="list-style-type: none"> ● Double press the joystick (8) to enter main menu. ● Press the joystick (8) forward or backward to select Zeroing>Distance option and short press the joystick (8) to confirm the zeroing distance (e.g.25m). ● Move the cursor of secondary menu by the pressing joystick (8) to enter Gun menu. ● In the tertiary menu, move the cursor with the joystick (8) to add Gun type when selecting “+” icon. ● Short press the joystick (8) for selecting Gun type, and short press the joystick(8) to left to go back to the previous screen. <p>Notice: Zeroing at a temperature close to the scope’s operating temperature is recommended. The FOV of 20mm/25mm and 60mm/50mm needs to be zeroed separately with the same method. The zeroing profile for FOV of 20mm/25mm and 60mm/50mm should be kept consistent. Zeroing model includes Auto Zero and Manual Zero, reference as follow.</p>	

Zeroing

1. Auto Zeroing



- Short press the joystick (8) forward or backward to select Auto Zero>zero distance, and confirm the selection by short pressing the “OK” button.
- When you are ready, press “OK” and finish the shooting within 15s.
- Short press the joystick (8) to save the zeroing data to any profile (A, B, C, D, E).
- Finally, long press the joystick (8) to exit.

Notice:

Please refer to “Zeroing Profile” for detailed operation steps.

2. Manual Zeroing





- Move the cursor to Manual Zero.
- Short press the joystick (8) to enter the Manual Zeroing, confirm the zeroing distance, and short press “OK” to enter the next step.
- After your first shooting is finished, align the reticle with point of aiming, and move the cursor to turn on Freeze ❄️ function and one screenshot would be taken (the freeze function allows you to freely move or manipulate the scope without losing reticle placement on the point of aim during adjustments).
- Select the magnification icon 🔍 when necessary, it will improve the accuracy of zeroing.
- Adjust the coordinates (X, Y) of the reticle by joystick(8), and move the reticle from the original position to the bullet hole position manually.
- Short press the joystick (8) to save the zeroing data to any profile (A, B, C, D, E). Finally, long press the joystick(8) to exit current screen.

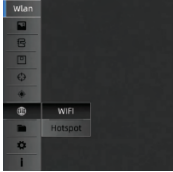
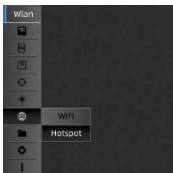
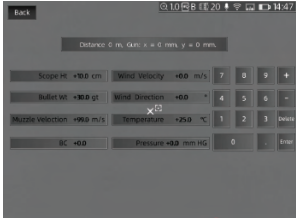

Notice:

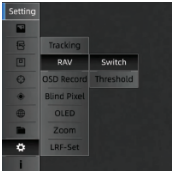
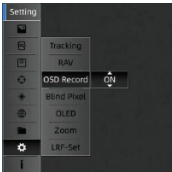

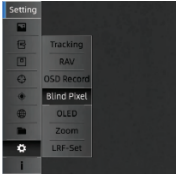
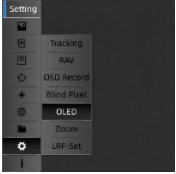

- ◆ The changes will always be saved based on your last calibration, e.g. the first saved coord is (-20, 35) in Profile A and you may want a tiny change like (-5,5), so the device finally displays (-25,40), though it displays (0,0) before your second calibration.
- ◆ Please get back to the main menu to choose other profiles if you would like to save new data for another gun. It is suggested to save the subsequent changes where you first time saved for the same gun. It is not recommended to save a change in Profile A firstly then another change saved in Profile B or C.

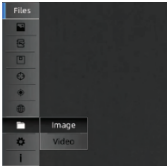
<h2 style="text-align: center;">WiFi & Hotspot</h2>	<h3 style="text-align: center;">WiFi function on/off</h3>	 <ul style="list-style-type: none"> ● Double press the joystick (8) to enter the main menu. ● Move the joystick (8) to choose Wi-Fi function. ● Press the joystick (8) one time to turn on or off the wifi function. ● The Wi-Fi icon is blue and displays on the status bar at the top right corner. <p>Notice: The hotspot of the smart phone should be turned on before Vidar' s wifi function is enabled.</p>
	<h3 style="text-align: center;">Hotspot on/off</h3>	 <ul style="list-style-type: none"> ● Double press the joystick (8) to enter main menu. ● Move the joystick (8) to choose Hotspots function. ● Press the joystick (8) one time to turn on or off the hotspots function. ● Set the name and password, and press the joystick (8) to confirm. ● Search the hotspot for connecting the device to the smart phone. ● Open the "Smart Thermal" APP to view the images remotely.
<h2 style="text-align: center;">Ballistic Calculation</h2>	<h3 style="text-align: center;">Trajectory</h3>	<ul style="list-style-type: none"> ● Double press the joystick (8) to enter main menu. ● Move the joystick (8) to choose the icons Zeroing>Trajectory>Setting , and configure the parameters of Scope Ht, Wind Velocity, Bullet Wt, Wind Direction, Muzzle Velocity, Temperature, BC and Pressure as needed. ● When any parameter is selected for modification, the cursor would automatically move to the keyboard section at the right side of the screen. ● Click Enter and the cursor will return to left side of the screen. ● Move the cursor and click the Back icon to return to the previous screen.  <p>Notice:</p> <ul style="list-style-type: none"> ◆ The middle of the OLED would appear icon "X" for calculation when trajectory is enabled. User takes "X" to aim related object when "X" is mismatching with zeroing coordinates. ◆ User should type in related parameter on the trajectory setting screen.

	<p>This function is used to set the Tracking, RAV, OSD Record, Blind Pixel, OLED, Zoom and LRF-Set.</p> <ul style="list-style-type: none"> ● Double press the joystick (8) to enter the main menu. ● Move the cursor to select the Setting icon. ● Press the joystick (8) to enter the submenu of Setting and set the functions accordingly. 	
<h1>Setting</h1>	<h2>Tracking</h2>	 <ul style="list-style-type: none"> ● In the Setting submenu, move cursor to Tracking icon. ● Click the joystick (8) to appear ON/OFF option. ● Press the joystick (8) forward or backward to confirm the selection. <p>Notice: The OLED would appear throbbing blue icon (reference as right picture) which can mark the target with the highest temperature in real time on the screen.</p>
	<h2>RAV</h2>	 <ul style="list-style-type: none"> ● Move the cursor to RAV option. ● Press the joystick (8) to show Switch/VPT options. ● Press the joystick (8) to turn on/off this function. ● Press the joystick (8) to VPT for setting voice value of shooting. <p>Notice: The Vidar would automatically record videos during shooting. Meanwhile it would record a 10s video before and after shooting respectively.</p>
	<h2>OSD Record</h2>	 <ul style="list-style-type: none"> ● Move the cursor to OSD icon. ● Press the joystick (8) to show ON/OFF option. ● Press the joystick (8) forward or backward to confirm the selection. <p>Notice: The OLED would not display all icons on the main menu when recording videos.</p>

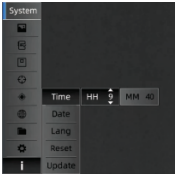
Setting	Blind Pixel	<p>User can operate blind spot replaced function when vidar pups up blindness.</p>  <ul style="list-style-type: none"> ● Press the joystick (8) to setting interface, and move cursor to Blind Pixel option. ● Press the joystick (8) to show the tertiary menu which is Cancel, Save and Replace option. ● Forward or backward by joystick (8) for Replace function, then press joystick to replace. ● Press the joystick (8) one time to save your current operations. <p>Notice: Please user firstly closes lens cover when using this function.</p>
	OLED	 <ul style="list-style-type: none"> ● Move the cursor to OLED icon. ● Press the joystick (8) that would appear Brightness and Color options. ● Press the joystick (8) to select Brightness value(1--5) that can control OLED' s brightness. ● Press the joystick (8) to Color for setting background hue of OLED. <p>Notice: The color palette that user can select gray,blue,purple and red for inter-operation.</p>
	Zoom	<p>There are two options for choice when user meets kinds of moving object.</p>  <ul style="list-style-type: none"> ● Move the cursor to Zoom option. ● Press the joystick(8) to appear Smooth/Rapid option. ● Forward or backward to press joystick(8) one time for confirmation. <p>Notice: The Smooth is suitable for common moving object , that means the speed of zooming is more uniform, rapid that it is suitable for fast moving target tracking.</p>
	LRF-Set	<p>There is laser indicated direction for OLED, and commonly its coordinates cannot be changed.</p>  <ul style="list-style-type: none"> ● Move the cursor to LRF-Set option. ● Press the joystick to show the info of laser coordinates (X, Y). ● Select and click Back via joystick (8) to exit. <p>Notice:</p> <ol style="list-style-type: none"> 1.Short press the joystick to the left for continuous ranging. When the ballistic calculator is turned on, it is set for single ranging. 2.When the laser ranging function is activated, the icon at the upper right corner would turn to blue.

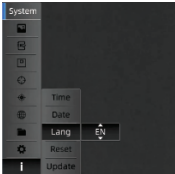
<p style="text-align: center;">File</p>	<p style="text-align: center;">Image</p>	<p>User can check and download the corresponding snapshot.</p>  <ul style="list-style-type: none"> ● Double press joystick (8) to enter main menu. ● Press joystick (8) to select Files option. ● Press the joystick (8) to select Image option. ● Click confirmation by joystick (8), and would appear the current snapshots user took. ● Move the cursor to related position of snapshot, then click joystick (8) for checking. ● Select Back and click joystick (8) to return. <p>Notice:</p> <ul style="list-style-type: none"> ◆ There are different file names by time in the format of xxxx(year)--xx(month)--xx(day)--xx(hour)--xx-(minute)--xx(secs). ◆ Select Delete,Delete all,Prev,Next,Play and Back options when user open related image by joystick (8).
	<p style="text-align: center;">Video</p>	 <ul style="list-style-type: none"> ● User can check and download the corresponding video, operating method is same as above with image steps. <p>Notice: Can select Delete,Delete all,Prev,Next,Play and Back options when user opens related video by joystick(8).</p>
<p style="text-align: center;">System</p>	<p>System is used for setting the Time, Date, Language, Reset and Update functions.</p> <ul style="list-style-type: none"> ● Double press joystick (8) to enter the main menu. ● Move the cursor to select the System option. ● Press the joystick (8) to enter the submenu of the System which allows user to set some function, operation steps shown as follow. 	

System	Time	 <ul style="list-style-type: none"> ● Press joystick (8) to select Time option. ● Press joystick (8) to set HH (hour) and MM (minute). ● Press confirmation by joystick(8) for setting save, meanwhile the time is accordingly changed in the status of bar.. ● Press joystick (8) to left once for back to up one level. 							
	Date	 <ul style="list-style-type: none"> ● Press joystick (8) to select Date option. ● Press joystick (8) to set YY (year), MM (month), DD (day) by moving cursor up and down. ● Press confirmation by joystick(8) for setting save. ● Press joystick (8) to left once for back to up one level. <p>Notice: The date format is as YY (year)--MM (month)--DD (day) in system.</p>							
	Language	 <ul style="list-style-type: none"> ● Press joystick (8) to select Lang option. ● Press joystick (8) up and down to set language. ● Press confirmation by joystick (8) for setting save, meanwhile system would automatically display switch of language. ● Press joystick (8) to left once for back to up one level. 							
	Reset	 <ul style="list-style-type: none"> ● Press joystick (8) to select Reset option. ● Press joystick (8) to restore default status of factory. ● Press joystick (8) to left once for back to the upper menu. <p>Notice: After the factory reset is chosen, the following functions is accordingly restored:</p> <table style="width: 100%; border: none;"> <tr> <td>✓ OLED: Gray;</td> <td>✓ WiFi&Hotspot: Off;</td> </tr> <tr> <td>✓ RAV: Off;</td> <td>✓ Tracking: Off;</td> </tr> <tr> <td>✓ Zeroing distance: 25m;</td> <td>✓ Optical Zoom:1.0X;</td> </tr> <tr> <td>✓ Profile mode: A;</td> <td></td> </tr> </table>	✓ OLED: Gray;	✓ WiFi&Hotspot: Off;	✓ RAV: Off;	✓ Tracking: Off;	✓ Zeroing distance: 25m;	✓ Optical Zoom:1.0X;	✓ Profile mode: A;
✓ OLED: Gray;	✓ WiFi&Hotspot: Off;								
✓ RAV: Off;	✓ Tracking: Off;								
✓ Zeroing distance: 25m;	✓ Optical Zoom:1.0X;								
✓ Profile mode: A;									

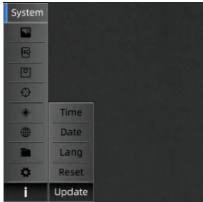
System	Update	<p>This interface is used for updating firmware. Connect the device to PC via magnetic data cable first.</p>  <ul style="list-style-type: none"> ● Copy the related updating firmware to the file folder of Vidar. ● Press the joystick (8) to select the Update icon. ● The system will prompt “Program Updating”. ● When the update is finished, the device will restart automatically. ● Enter the Reset menu to check the firmware version.
---------------	---------------	---

13 Reticle

User can set up parameter of the reticle if it is necessary, there are included Type, Dot, Location, Brightness and Mode.

13.1 Type

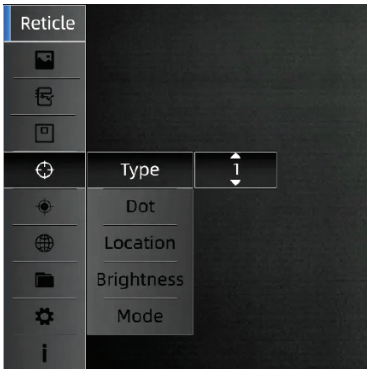

That is mean totally seven reticle styles user can inter-switch.

- ◆ Double press the joystick(8) to enter main menu.
- ◆ Move cursor to the reticle option and click confirmation.
- ◆ Select type of reticle(1--7) which user want to use.
- ◆ Click confirmation and return to upper menu by pressing joystick (8) to the left.

13.2 Dot

Dot means that the point of middle of reticle can be adjusted by Green, Red and Blue.

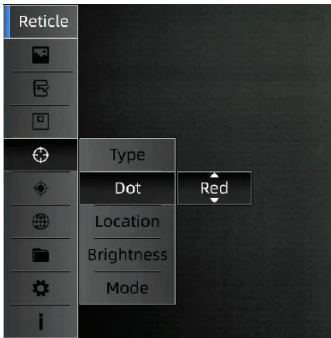

- ◆ Double press the joystick (8) to enter main menu.
- ◆ Move cursor to the Dot option and click confirmation.
- ◆ Select the point of the reticle which user want to use.
- ◆ Click confirmation for saving operation and return to upper menu by pressing joystick (8) to the left.

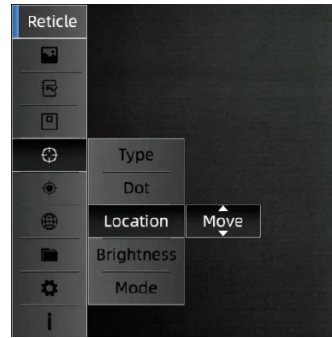

- ◆ Double press the joystick(8) to enter main menu.
- ◆ Move cursor to the location option and select Move or Center type by forward and backward press joystick(8).
- ◆ Click confirmation for saving operation and return to upper menu by pressing joystick (8) to the left.

Notice:

- Under 1x magnification, the location of the reticle keeps the same as the zeroing coordinates. The reticles will be returned to the center of the screen when image is zoomed in.
- When zeroing is finished, the screen will be slightly enlarged based on the zeroing coordinates. The reticles will be returned to the center of the screen. When zoomed in/out, the reticle is always enlarged at the center of the OLED.

13.3 Location

There are two styles of Move and Center.

13.4 Brightness

There is a option of brightness that can adjust the luminance value of reticle, totally three brightness values user can configure to the reticle.

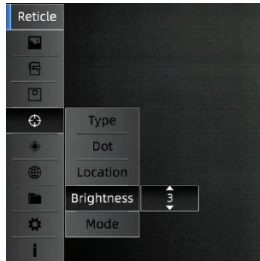

- ◆ Double press the joystick(8) to enter main menu.
- ◆ Move cursor to the reticle option and click confirmation.
- ◆ Select type of brightness which user want to use.
- ◆ Click confirmation for saving operation and return to upper menu by pressing joystick(8) to the left.

13.5 Mode

There are two reticle modes to for selection, i.e. SFP and FFP.

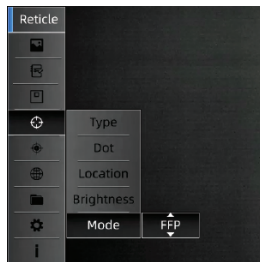

SFP: The reticle always keeps the same size even if user changes magnification of image.

FFP: The reticle will be enlarged as its magnification changes when selecting FFP mode.

- ◆ Double press the joystick (8) to enter main menu.
- ◆ Move cursor to the reticle option and click confirmation.
- ◆ Select type of mode with FFP/SFP which user wants to use.
- ◆ Click confirmation for saving operation and return to upper menu by pressing joystick (8) to the left.

14 PIP (Picture in Picture)

The image is enlarged by 2x as centered position by the crosshairs. Picture-in-picture occupies 10% of an entire image.



- ◆ Double press the joystick(8) to enter main menu.
- ◆ Move cursor to the PIP icon and click confirmation.
- ◆ Press joystick(8) forward or backward to select ON/OFF.
- ◆ Click confirmation for saving operation and return to upper menu by pressing joystick(8) to the left.

Notice: It will appear an enlarged image always keeps in the screen when user enable PIP function, it will disappear in the screen when OFF is selected.

15 Download “Smart Thermal” APP

User can search "Smart Thermal" in Apple or Google Play APP Store to download our APP, or can download it through the QR code shown on the packing box or user manual.

16 Technical Inspection

It is recommended to carry out a technical inspection for each time before using the vidar, check the following:

- ◆ The Vidar appearance (there should be no cracks on the body).
- ◆ The condition of the object lens and eyepiece (there should be no cracks, greasy spots, dirt or other deposits).
- ◆ The state of rechargeable battery (should be charged normally).
- ◆ The controls/buttons and other parts should be in working order.

17 Maintenance

For the Vidar which user should maintain in half one year no less one time.

- ◆ Wipe an external surface of metal and plastic parts off dust with a cotton cloth. Silicone grease may be used for cleaning process.
- ◆ Clean an electric contacts and battery slots on the riflescope using a non-greasy organic solvent.
- ◆ Check the optics of the lens and the eyepiece. If necessary, remove the dirt and sand from the optics (it is perfect to use a non-contact method).
- ◆ Cleaning of the exterior of the optics should be done with cleaners designed especially for this purpose.

18 Update and ThermTec Outdoor

ThermTec Vidar series scope supports ThermTec Outdoor technology, which allows user to transmit the image from the vidar to the smartphone or PC via Wi-Fi in real time mode. User can check some detail instruction from the official ThermTec website (www.thermeyer-tec.com).

ThermTec provides the software update option, it is feasible to download and update software from the official website.

Follow the below steps to update the firmware as needed.

Step 1:

Connect the device to PC via magnetic data cable.



Step 3:

Enter Reset menu to check firmware version.

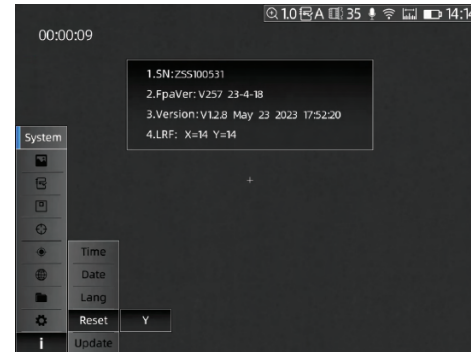

Step 2:

Copy the related updating firmware to the file folder of vidar. Press the joystick(8) to select Update icon, and the system will prompt "Program Updating".

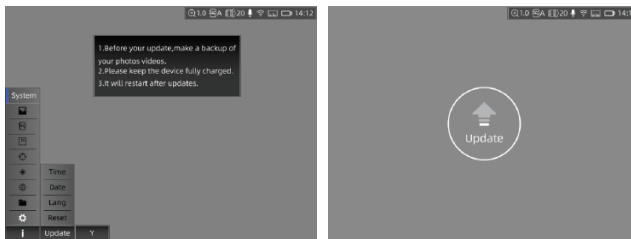

Information to the User

Any Changes or modifications not expressly approved by the party responsible for compliance could void the user's authority to operate the equipment.

Note:

The manufacturer is not responsible for any radio or TV interference caused by unauthorized modifications to this equipment. Such modifications could void the user's authority to operate the equipment.

This device was tested for typical body-support operations. To comply with RF exposure requirements, a minimum separation distance of 0.5cm must be maintained between the user's body and the handset, including the antenna. Third-party belt-clips, holsters, and similar accessories used by this device should not contain any metallic components. Body accessories that do not meet these requirements may not comply with RF exposure requirements and should be avoided. Use only the supplied or an approved antenna.

ThermTec Technology Co., Ltd., hereby declare that this product was tested conforming to the applicable CE&FCC rules under the most accurate measurement standards possible, and that all the necessary steps have been taken and are in force to assure that production units of the same an equipment will continue to comply with the commissions requirements.

ThermTec

DISTRIBUTED BY  **SPIKA**

contact@spika.com.au
www.spika.com.au

   SPIKA.TEAM

   ThermTec Outdoor