



VIDAR 2.0 Series
Thermal Imaging

Thermal Imaging Scope Vidar2.0 Series User Manual



Model No.:

Vidar3352.0/Vidar3602.0/Vidar6502.0/Vidar6602.0
Vidar335L2.0/Vidar360L2.0/Vidar650L2.0/Vidar660L2.0



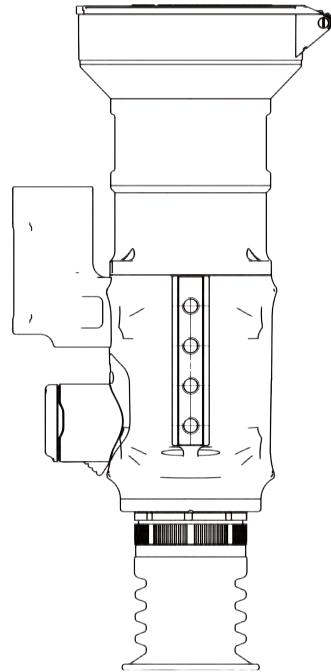
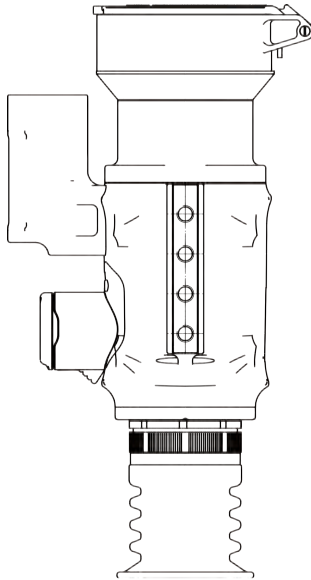
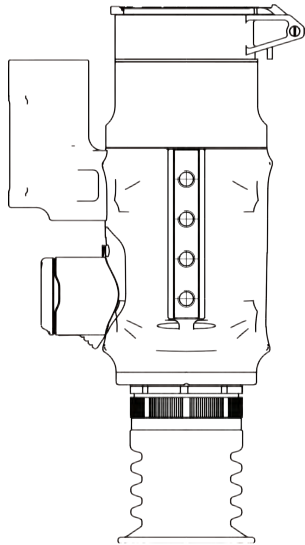

Table of Contents

Important Safety Information	6	10. Status Bar	23
1. Introduction	9	11. Memory Access	23
2. Features	9	12. Main Menu	23
3. Specifications	10	13. Reticle	32
4. Packing List	12	13.1 Type	32
5. Appearance of Vidar 2.0	14	13.2 Color	33
6. Buttons and Controls	16	13.3 Brightness	33
7. Installation Guide	17	13.4 Dot	33
7.1 Battery Installation	17	13.5 Location	34
7.2 Picatinny Rail Installation	18	13.6 Mode	35
8. Operation Guide	18	13.7 Reversal	35
8.1 Turn ON the Device	18	14. PIP (Picture in Picture)	35
8.2 Pseudo Color Switch	19	15. Technical Inspection	36
8.3 Target Outline Mode	20	16. Maintenance	36
8.4 Turn OFF the Device	20	17. ThermTec Outdoor – Mobile Application	36
8.5 Standby Mode	21	18. Firmware Upgrade	37
8.6 Diopter Adjustment	21	18.1 Upgrade via PC	37
8.7 Objective Lens Focusing	21	18.2 Upgrade via ThermTec Outdoor	37
8.8 FOV Selection and Switch	21		
9. Digital Zoom	22		

IMPORTANT SAFETY INFORMATION

Environmental influences

WARNING! Prohibition that the lens of the device immediately look towards at intense heat such as the sun or laser device. The objective lens and eyepiece can have an influence on a burning glass and damage the internal components, the guarantee does not cover damage caused by incorrect operation.

Safety instructions for use

- Handle the device and battery pack with care: rough handling may damage the battery pack.
- Do not expose the device to fire or high temperatures.
- Only use the battery charger included in the delivery package.
- The battery capacity decreases when operated in a cold ambient temperature. This is not a fault and occurs for technical reasons.
- Always store the device in its carrying bag in a dry, well-ventilated space. For prolonged storage, remove the batteries.
- Do not expose your device to extreme temperatures lower than - 20°C and higher than + 50°C.
- The product shall only be connected to a USB Type C interface.
- If the device has been damaged or the battery is defective, send the device to our after-sales service for repair.

Safety instructions for the power supply

- Check the power supply unit, cable and adapter for visible damage before use.
- Do not use any defective parts. Defective components must be replaced.
- Do not use the power supply unit in wet or humid environments.
- Only use the original cable provided with the battery charger.
- Do not make any technical modifications.

For further information and safety instructions, please refer to the User Manual provided. It is also available on our website in the download center: www.thermeyer.com.

Regulatory information



This product and - if applicable - the supplied accessories too are marked with "CE" and comply therefore with the applicable harmonized European standards listed under the Directive 2014/53/EU (RED), Directive 2014/30/EU (EMC), Directive 2014/35/EU (LVD), Directive 2011/65/EU (RoHS).

**UK
CA**

This product and - if applicable - the supplied accessories too are marked with “UKCA” and comply therefore with the following directives: Radio Equipment Regulations 2017, Electromagnetic Compatibility Regulations 2016, Electrical Equipment (Safety) Regulations 2016, the Restriction of the Use of Certain Hazardous Substances in Electrical and Electronic Equipment Regulations 2012.

RoHS

This product and - if applicable - the supplied accessories too are marked with “RoHS” and comply therefore the requirements of Directive 2011/65/EU on the restriction of the use of certain hazardous substances in electrical and electronic equipment (“RoHS recast” or “RoHS 2”).



2012/19/EU (WEEE directive): Products marked with this symbol cannot be disposed of as unsorted municipal waste in the European Union. For proper recycling, return this product to your local supplier upon the purchase of equivalent new equipment, or dispose of it at designated collection points. For more information see: www.recycle-this.info.



Directive 2006/66/EC and its amendment 2013/56/EU (Battery Directive): This product contains a battery that cannot be disposed of as unsorted municipal waste in the European Union. See the product documentation for specific battery information. The battery is marked with this symbol, which may include lettering to indicate cadmium (Cd), lead (Pb), or mercury (Hg). For proper recycling, return the battery to your supplier or to a designated collection point. For more information see: www.recyclethis.info.

For business customers within the European Union

Please contact your dealer or supplier regarding the disposal of electrical and electronic devices who will provide you with further information.

Information on disposal in other countries outside of the European Union

This symbol is only applicable in the European Union. Please contact your local authority or dealer if you wish to dispose of this product and ask for a disposal option.

Intended user

The device is intended for displaying heat signatures during nature observation, remote hunting observations and for civil use. This device is not a toy for children.

Use the device only as described in this User Manual. The manufacturer and the dealer accept no liability for damages which arise due to non-intended or incorrect use.

Installing/removing the battery

The vidar 2.0 series thermal imaging scope is equipped with two power supply systems – one built-in battery pack and the other replaceable 18650 battery. The built-in battery pack cannot be removed.

CAUTION



CAUTION



Avoid hard objects.



Do not aim the lens directly at the sun or high-temperature light sources.



Do not use the device in extremely cold or hot environment.



Charge the battery once every three months when it is not used for a long period of time.



Do not irradiate the laser indicator of the device to human eyes.



Do not disassemble or modify the device by yourself in any way.

1 Introduction

Compact Vidar 2.0 Series thermal imaging scope is equipped with 12μm high-sensitivity detector with the resolution up to 640x512, which adopts a variety of lenses with different focal lengths, a 1024x768 high-definition OLED display, as well as a laser rangefinder, providing a clear view over long distances in harsh environments, poor visibility, or even total darkness. Vidar 2.0 allows users to see through obstacles that hinder the detected target, and accurately measure the actual distance to the target. In addition, it's easy to connect to our mobile application to achieve live view and share your findings.

Vidar 2.0 Series thermal imaging scope is designed for a wide range of applications, including night hunting, observation, rescue operations, hiking, and traveling, etc.

2 Features

- ◆ Dual FOV
- ◆ Ballistic Calculation
- ◆ Auto Zeroing
- ◆ Laser Rangefinder up to 1200m
- ◆ Built-in Memory up to 64GB
- ◆ Compact Design
- ◆ Automatic Object Detection
- ◆ Easy Battery Installation
- ◆ Picture in Picture Function
- ◆ 1.0-4.0X Smooth & Rapid Zoom
- ◆ RAV Function
- ◆ Various Pseudo Colors
- ◆ Polarity Reversal for Crosshairs

3 Specification - Vidar 3/6 2.0

Model	Vidar335 2.0	Vidar360 2.0	Vidar650 2.0	Vidar660 2.0
Microbolometer				
Type	Uncooled			
Resolution	384x288		640x512	
Pixel pitch	12µm			
NETD	≤18mK	≤20mK	≤18mK	≤20mK
Spectral range	8-14µm			
Frame rate	50HZ			
Detection Range	1800m	1000/3000m	2600m	1000/3000m
Optics				
Objective lens	35mm, F1.0	20/60mm, F1.0	50mm, F1.0	20/60mm, F1.0
Field of view	7.5°x5.6°	13.1°x9.8°/ 4.4°x3.3°	8.8° x 7.0°	21.7°x17.4°/ 7.3°x5.9°
m@100m	13.2x9.9	23x17.3/7.7x 5.8	15.4x12.3	38.4x30.7/12.8x 10.2
Magnification	3.2X	1.8X/5.5X	2.8X	1.1X/3.2X
Digital zoom	1.0-4.0X smooth & rapid zoom			
Eye relief	45mm			
Exit pupil	6mm			
Diopter	±5D			
Aiming Reticle				
Reticle	7			
Reticle color	5, Black, White, Red, Green, Blue			
Display				
Type	AMOLED			
Resolution	1024x768			
Display size	0.39 inch			
Color palette	6			

Function				
Max. recoil power on rifled weapon	6000J			
RAV	Yes			
Audio Recording	Yes			
Auto zeroing	Yes			
Manual zeroing	Yes			
Zeroing profiles	5			
Freeze Zeroing	Yes			
Picture-in-picture	Yes			
AI ranging	Yes			
Image calibration	Manual/Auto			
Video Recorder				
Phone/video playback	Yes			
Inbuilt memory	64GB			
Interface				
Magnetic interface	Data transfer			
Hotspot	Yes			
Battery				
Battery type	Replaceable, 2*18650			
Battery life	18h	18h	16h	16h
Operating temperature				
Operating temperature	-20 – +50°C			
IP rating				
IP rating	IP67			
Weight, g	566	825	625	825
Size, mm	188*92.2*7 2	233.2*100. 4*74.9	200.9*95.7 *72	233.2*100. 4*74.9
Accessories				
External cable	Magnetic interface data cable			
Other accessory	Standard Picatinny rail, eyeshade, charger and etc.			

Specification - Vidar 3L/6L 2.0

Model	Vidar335L 2.0	Vidar360L 2.0	Vidar650L 2.0	Vidar660L 2.0
Microbolometer				
Type	Uncooled			
Resolution	384x288		640x512	
Pixel pitch	12µm			
NETD	≤18mK	≤20mK	≤18mK	≤20mK
Spectral range	8-14µm			
Frame rate	50HZ			
Detection Range	1800m	1000/3000m	2600m	1000/3000m
Optics				
Objective lens	35mm, F1.0	20/60mm, F1.0	50mm, F1.0	20/60mm, F1.0
Field of view	7.5°x5.6°	13.1°x9.8°/ 4.4°x3.3°	8.8° x 7.0°	21.7°x17.4°/ 7.3°x5.9°
m@100m	13.2x9.9	23x17.3/7.7x5.8	15.4x12.3	38.4x30.7/12.8x10.2
Magnification	3.2X	1.8X/5.5X	2.8X	1.1X/3.2X
Digital zoom	1.0-4.0X smooth & rapid zoom			
Eye relief	45mm			
Exit pupil	6mm			
Diopter	±5D			
Aiming Reticle				
Reticle	7			
Reticle color	5, Black. white, red, green, blue			
Display				
Type	AMOLED			
Resolution	1024x768			
Display size	0.39 inch			
Color palette	6			

Function				
Max. recoil power on rifled weapon	6000J			
RAV	Yes			
Audio Recording	Yes			
Auto zeroing	Yes			
Manual zeroing	Yes			
Zeroing profiles	5			
Freeze Zeroing	Yes			
Picture-in-picture	Yes			
Laser ranging	1200m			
Ballistic Calculator	Yes			
Image calibration	Manual/Auto			
Video Recorder				
Phone/video playback	Yes			
Inbuilt memory	64GB			
Interface				
Magnetic interface	Data transfer			
Hotspot	Yes			
Battery				
Battery type	Replaceable, 2*18650			
Battery life	18h	18h	16h	16h
Environment				
Operating temperature	-20 – +50°C			
IP rating	IP67			
Weight, g	628	887	687	887
Size, mm	188*103.5 *72	233.2*111. 7*74.9	200.9*107 *72	233.2*111. 7*74.9
Accessories				
External cable	Magnetic interface data cable			
Other accessory	Standard Picatinny rail, eyeshade, charger and etc.			

4 Packing list



Vidar2.0 scope
1pcs



Eyepiece hood
1pcs



Charger
1pcs



Picatinny rail
1pcs



Magnetic data
cable
1pcs



Lithium battery
4pcs



Allen key
1pcs
Small Allen key
1pcs



T2.9 Screw
3pcs



Lens cloth
1pcs



5 Appearance of Vidar

5.1 Single FOV

1. Laser ranging
2. Magnetic USB
3. 18650 battery with 2pcs
4. Battery box
5. Eyeshade
6. Diopter ring
7. Power button
8. Joystick
9. Lens Focusing Knob
10. Lens cover



5.2 Dual FOV

1.Laser ranging

2.Magnetic USB

3.18650 battery with 2pcs

4.Battery box

5.Eyeshade

6.Diopter ring

7.Power button

8.Joystick

9.Lens Focusing Knob

10.Lens cover

11.Dual FOV shift



6 Buttons and Controls

	Short Press	Screen will be locked after entering standby mode. A short press on the power button during three-second countdown to OFF will return you to device's main interface.
	Long Press	ON/OFF
	Before the Entry of Main Menu	
	Double Press	Image Calibration

	Before the Entry of Main Menu							
	Long Press Upward	Long Press Downward	Short Press to the Right	Long Press to the Right	Short Press to the Left	Double Press	Press	Long Press
Zoom in	Zoom out	Pseudo Color Switch	Target Outline Mode	Continuous Ranging ON/OFF (Auto Switch to Single Ranging when Ballistic Calculation is ON)	Main Menu	Take Photos	Take Videos	

7 Installation Guide

7.1 Battery Installation

Install 2pcs of 18650 battery to the battery slot. Please make sure that one battery is installed with the positive pole outwards, while the other battery is installed with the negative pole outwards, as shown in the below pictures.



Open the battery cover

Press the battery cover first, and then press the buckle at the same time to open the cover.



Close the battery cover

Press the buckle first, and then press the battery cover at the same time to close the cover.



Notice: The battery icon would turn to red when the device is out of power, and the lithium battery has to be replaced for charging.

7.2 Picatinny Rail Installation

Take the picatinny rail and 3 pieces of screws to fix the bottom hole of Vidar 2.0 into suitable position.

Timely adjust the position of Picatinny Rail and Vidar 2.0 during installing, to ensure comfortable target observations.



Note: It is recommended to install Vidar 2.0 as low as possible, and keep it away from the barrel. Screws must be fixed tightly when position adjustment is finished.

8 Operation Guide

8.1 Power-on the Device



1. Press power button for a while till OLED display is powered on.



The screen after turning on the device

8.2 Pseudo Color Switch

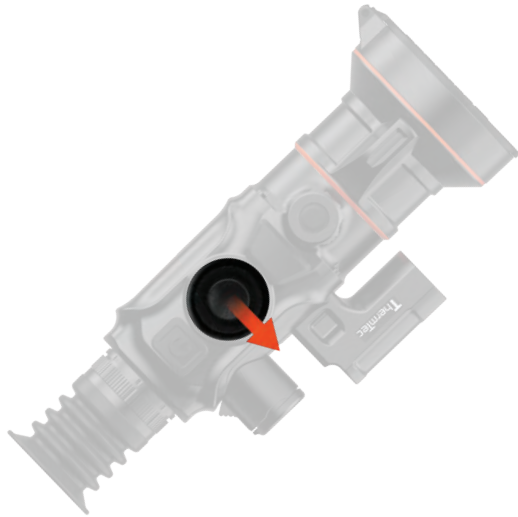

White hot



Black hot



Red hot



Green



Golden



Violet

Hands-On: Short press the joystick (8) towards right once each time for switching pseudo colors.

There are six optional pseudo colors: White Hot, Black Bot, Red Hot, Green, Golden, Violet.

8.3 Target Outline Mode

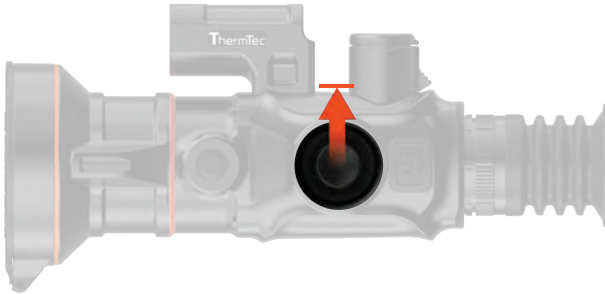

Long press the joystick (8) towards right to turn ON/OFF the Target Outline Mode.



Target Outline Mode

8.4 Turning off the Device



Long press the power button (7) for consecutive 3 seconds to turn OFF the device.

Note: A short press of the power button (7) during three-second countdown to OFF could return the device to its normal working state.

8.5 Standby Mode



Short press the power button (7) to enter the standby mode.

8.6 Diopter Adjustment



Rotate slowly the diopter ring (6) to adjust the diopter level for optimizing the image sharpness on the OLED display.

8.7 Objective Lens Focusing



Adjust the objective lens focusing knob when necessary for defining an image.

8.8 FOV Selection and Shift (for Vidar360(L)/660(L)2.0)

The device is equipped with dual-field of view. Rotate the Dual-FOV Switch (11) to switch the lens focal length from 20mm to 60mm or from 60mm to 20mm (for Vidar 360(L)/660(L) 2.0) .

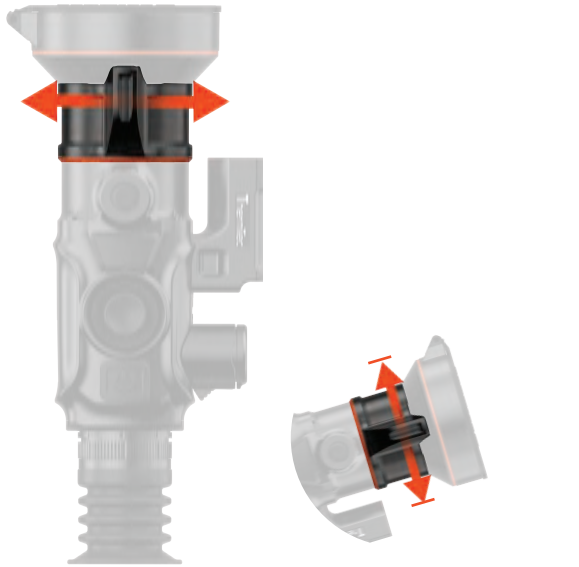

Shift the FOV from 60° to 20°

FOV successfully shifted

9 Digital Zoom

Vidar series support 1.0-4.0X continuously adjusted digital zoom function.

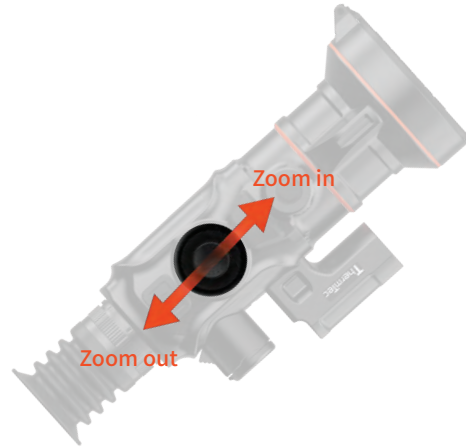

Press the joystick (8) to adjust the focus distance. Press upwards for zooming in, downwards for zooming out.

Notice: Under the rapid zoom mode, Vidar 2.0 can carry out integral digital zoom.

For more details, please refer to the section of Zoom later.

10 Status Bar

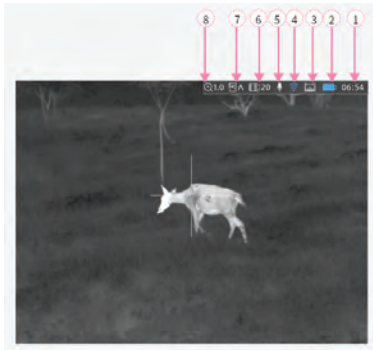

The status bar shows information about the device's current operating information. The contents of each icon are as follows:

1. Time (Setting Method: Main Menu>System>Time.)
2. State of Battery (Remember to charge the battery when the icon turns to red.)
3. Laser Rangefinder (The icon will turn blue when the LRF is enable.)
4. WLAN (Connection state if hot spot & WIFI would be set up or not.)
5. Audio (Audio for video recording and RAV.)
6. Focal Length of Objective Lens (Vidar360(L)/660(L) 2.0 Series support manual switch of 20/60mm focal length based on dual FOV characteristic.)
7. Zeroing Profile (Zeroing profile that.)
8. Current Digital Zoom (Rapid zoom for Smooth 1.0-4.0X; 1.0X for default setting.)

11 Memory Access

Turn on Vidar 2.0, users could connect it to PC via a magnetic charging cable.

Meanwhile, the device will be recognized as a flash drive on the PC, allowing users to download photos or videos as needed.





Notice:

- Users could still do other operations on the device while recording a video.
- Photos and videos captured or recorded will be stored on the memory card In the mainboard of Vidar 2.0.
- Please keep in mind that the built-in memory card has a capacity of 64GB. (If you frequently capture photos or record videos, it is necessary to regularly check the available space.)

12 Main Menu

- ◆ Double press the joystick (8) to enter the main menu.
- ◆ Press the joystick (8) forwards or backwards to switch function options on the main menu.
- ◆ Short press the joystick (8) to modify the parameters of the current option or enter the sub-menus.
- ◆ When moving the cursor to select an option icon, the color of the selected icon will change from gray to black.
- ◆ Press and hold the joystick (8) to save the current change. After that, press the joystick (8) toward left one more time to return to the main menu.

Main Menu Features and Direction

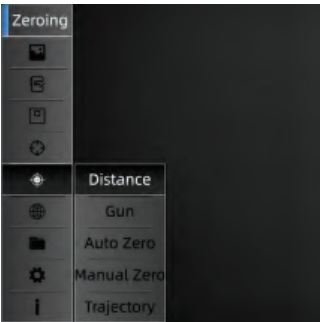
<p>Image</p> 	<p>Brightness</p>	<p>Adjust the Brightness to make the image brighter or dimmer. (Highest Value:10; Default Value:5)</p>
	<p>Sharpness</p>	<p>Adjust the Sharpness to make the edges of image sharper. (Highest Value:10; Default Value:5)</p>
	<p>Denoise</p>	<p>Adjust the Denoise to make the image cleaner. (Highest Value:10; Default Value:5)</p>
	<p>Contrast</p>	<p>Adjust the Contrast to make the image more prominent. (Highest Value:10; Default Value:5)</p>
<p>Zeroing Profile</p> 		<p>Choosing the Zeroing Profile Users could save five zeroing profiles from “A-E” in the sub-menu, each containing parameters after zeroing: distance, gun type, and reticle coordinates.</p> <ul style="list-style-type: none"> ● Double press the joystick (8) to enter the main menu. ● Press the joystick (8) to select Profile to enter the sub-menu. ● Press the joystick (8) forwards or backwards to select the profile you need from option A to E. ● The selected zeroing profile will appear in the top right corner of the status bar.
<p>Zeroing</p> 		<p>Setting Zeroing</p> <ul style="list-style-type: none"> ● Double press the joystick (8) to enter the main menu. ● Press the joystick (8) forwards or backwards to select Zeroing>Distance and short press the joystick (8) to confirm the zeroing distance (e.g.25m). ● Press joystick (8) to move the cursor of sub-menu to enter Gun menu. ● In the third-level menu, move the cursor with joystick (8) to add Gun type by selecting “+” icon. ● Short press the joystick (8) for selecting Gun type, and short press the joystick(8) to the left to back to the previous menu. <p>Notes:</p> <ul style="list-style-type: none"> • It is recommended to perform Zeroing at a temperature that close to the scope’ s operating temperature. • The FOV of lens with focal length of 20mm or 60mm needs to be zeroed in the same way respectively. The zeroing profile for FOV that with focal lengths of 20mm and 60mm should be consistent. Vidar 2.0 supports Auto Zero and Manual Zero. References are as follows.

Zeroing



1. Auto Zeroing

- Short press the joystick (8) forwards or backwards to select **Auto Zero** to enter Zero Distance menu, and confirm by short press the joystick (8) to select “OK” .
- When you are ready, press “OK” and finish the shooting within 15s.
- Short press the joystick (8) to save the zeroing data to any profile (A, B, C, D, E).
- Finally, short press the joystick (8) to select “Back” to exit.

Notes: Please refer to *Zeroing Profile* for more detailed operations.





2. Manual Zeroing





- Move the cursor to **Manual Zero**.
- Short press the joystick (8) to enter the next menu, confirm the zeroing distance, then short press “OK” to proceed.
- After your first shooting is completed, align the reticle with point of aim, and move the cursor to turn on **Freeze** function. After that, a screenshot will be taken. (The Freeze function allows you to freely move or manipulate the scope without losing reticle placement on the point of aim during adjustments.)
- Short press the joystick to change Magnification. If necessary, which helps to improve the accuracy of zeroing.
- Adjust the coordinates (X, Y) of the reticle by joystick(8), and move the reticle from the original position to the bullet hole position manually.
- Short press the joystick (8) to save the zeroing data to any profile (A, B, C, D, E). Finally, short press the joystick (8) to select “Back” to exit

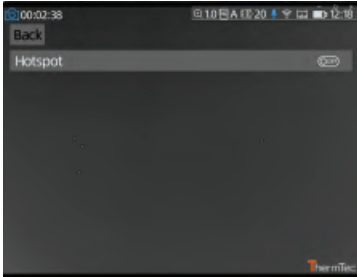

Notes:

- The changes will always be saved based on your last calibration, e.g. the first saved coordinate is (-20mm, 35mm) in Profile A and you may want a tiny change like (-5mm, 5mm), so the device will finally displays (-25mm, 40mm). If you enter the same weapon name and the same distance, the device will use data from the previous profile.
- Please get back to the main menu to choose other profiles if you would like to save new data for another gun. It is suggested to save the subsequent changes where you first time saved for the same gun. It is not recommended to save a change in Profile A firstly then another change saved in Profile B or C.

<p style="text-align: center;">Ballistic Calculation</p>	<p style="text-align: center;">Trajectory</p>	<ul style="list-style-type: none"> ● Double press the joystick (8) to enter the main menu. ● Short press the joystick (8) downwards to move the cursor to Setting, and short press the joystick (8) again to confirm. There, you can configure the parameters as needed, including Scope Ht, Wind Velocity, Bullet Wt, Muzzle Velocity, BC, Wind Direction, Temperature, and Pressure. ● When any parameter is selected for modification, the cursor would automatically move to the keyboard section on the right side of the screen. ● Click Enter and the cursor will return to left side of the screen. ● Move the cursor and click the Back icon to return to the previous screen. <div style="display: flex; justify-content: space-around;">   </div> <p>Notes:</p> <ul style="list-style-type: none"> ● Users first need to move the cursor to “ON” to activate the Trajectory function. ● After activation, an “^” icon will appear in the center of the screen. If the icon doesn’t match the coordinates after zeroing, users should aim it at the certain target, then fill in the actual parameters into the “Setting” interface. <p>Attention:</p> <ul style="list-style-type: none"> ◆ Trajectory adjustment needs to be performed after zeroing; otherwise, it has no practical significance. ◆ When Trajectory is turned on, the device will automatically switch to single ranging mode.
<p style="text-align: center;">WLAN</p> 	<p style="text-align: center;">Hotspot</p>	<div style="display: flex; justify-content: space-around;">  </div> <ul style="list-style-type: none"> ● Double press the joystick (8) to enter the main menu. ● Move the joystick (8) to select Hotspot function. ● Press the joystick (8) one more time to turn the hotspot function on or off. ● Set the name and password, then press the joystick (8) to confirm. ● Connect your mobile phone to device’s Hotspot via WLAN. ● After a successful connection, you can control the device via the ThermTec Outdoor APP.

<p style="text-align: center;">Setting</p> 	<p>In Setting menu, users could set functions below: Correction, Shutdown, Logo, Tracking, RAV, Blind Pixel, OLED, Zoom, LRF-Set, yd/m, etc.</p> <ul style="list-style-type: none"> ● Double press the joystick (8) to enter the main menu. ● Move the cursor to select the Setting icon. ● Press the joystick (8) to enter the sub-menu of Setting and configure the functions accordingly. 	
	<p style="text-align: center;">Correction</p>	<p>The image correction mode could be set to Auto or Manual.</p>  <ul style="list-style-type: none"> ● Move the cursor to Correction. ● Press the joystick(8) to view the options of Auto/Manual. ● Press the joystick(8) forwards or backwards one more time for confirmation. <p>Notes: With Auto mode turned ON, a countdown icon will appear on the status bar before calibration, and the image correction will be automatically carried out when the countdown is over.</p>
	<p style="text-align: center;">Shutdown</p>	<p>Turn on the Auto Shutdown if needed to avoid prolonged standby of device. Three options: 30 mins, 60 mins, 90mins.</p>  <ul style="list-style-type: none"> ● Move the cursor to Shutdown. ● Press the joystick(8) to view the options. ● Press the joystick(8) forwards or backwards one more time for confirmation.
	<p style="text-align: center;">Logo</p>	<p>Show or hide the Logo in the captured images or videos.</p>  <ul style="list-style-type: none"> ● Move the cursor to Logo. ● Press the joystick(8) to view the options of ON/OFF. ● Press the joystick(8) forwards or backwards one more time for confirmation.



Tracking



- Move the cursor to **Tracking**.
- Press the joystick (8) to view the options of **ON/OFF**.
- Press the joystick(8) forwards or backwards one more time for confirmation.

Notes: When Tracking is turned on, a bouncing box will appear on the live screen, marking the part of the target with the highest temperature.

RAV



- Move the cursor to **RAV**.
- Press the joystick (8) to view the options of **Switch/VPT**.
- Press the joystick (8) to turn on/off this function.
- Press the joystick (8) to **VPT (Default Value: 13)** for setting the voice value of shooting.

Notes: Vidar 2.0 will automatically record videos during shooting. Additionally, it will record a 10-second video before and after shooting, respectively.

Blind Pixel

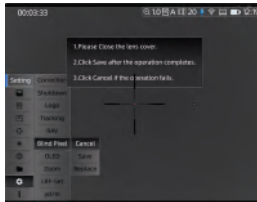

Use can operate blind spot replaced function when Vidar pups up blindness.

- Move the cursor to **Blind Pixel**.
- Press the joystick (8) to view the options of **Cancel, Save and Replace**.
- Move the cursor to **Replace** and press the joystick (8) for confirmation.
- Press the joystick (8) one more time to save your current operations.





Notes: If there is more than one Blind Pixel, click **Replace** for several times until all the Blind Pixels are gone.



OLED



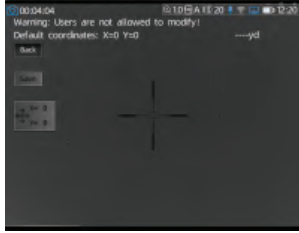



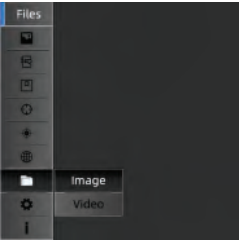
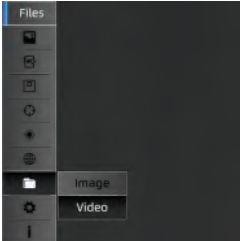

- Move the cursor to **OLED**.
- Press the joystick (8) to view the options of **Brightness and Color**.
- Press the joystick (8) to select Brightness value from 1 to 5.
- Press the joystick (8) to **Color** for setting the background tone of OLED.

Notes: There are four optional color palettes: gray, blue, purple, and red.

<p style="text-align: center;">Setting</p> 	<p style="text-align: center;">Zoom</p>	<p>There are two optional Zoom method for moving target: Smooth/Rapid.</p>  <ul style="list-style-type: none"> ● Move the cursor to Zoom option. ● Press the joystick(8) to view the options of Smooth/Rapid. ● Press the joystick(8) forwards or backwards one more time for confirmation. <p>Notes: Smooth is suitable for ordinary slow-moving target (the speed of zooming is more uniform), while Rapid is suitable for fast-moving target.</p>
	<p style="text-align: center;">LRF-Set</p>	 <ul style="list-style-type: none"> ● Move the cursor to LRF-Set. ● Press the joystick (8) to view the laser coordination(X,Y) info. ● Press the joystick(8) forwards or backwards to Save your changes and Back to exit. <p>Notes:</p> <ul style="list-style-type: none"> ◆ It is not recommended to change the default parameters of LRF. ◆ After activating laser ranging, the color of LRF icon in the top right corner of the screen will turn blue.
	<p style="text-align: center;">yd/m</p>	<p>Change the distance measurement unit between yard and meter as you want.</p>  <ul style="list-style-type: none"> ● Move the cursor to yd/m. ● Press the joystick (8) to view the options of yd/m. ● Press the joystick(8) forwards or backwards one more time for confirmation.

<p>Files</p> 	<p>Image</p>	<p>Users could view or download the images they have already captured here.</p>  <ul style="list-style-type: none"> ● Double press joystick (8) to enter main menu. ● Move the cursor to Files and press the joystick(8) for confirmation. ● Press the joystick (8) forwards or backwards to select Image. ● Now, users could see the list of captured images. ● Move the cursor to the position of a certain image, press joystick (8) for checking or download. ● Press the joystick (8) to Back for returning to the previous menu. <p>Notes:</p> <ul style="list-style-type: none"> • All images will be named in the format of xxxx(year)--xx(month)--xx(day)--xx(hour)--xx(minute)--xx(secs). • Options such as Delete, Delete All, Prev, Next, Play, and Back can be selected with the joystick (8) when viewing an image.
	<p>Video</p>	<p>Users could view or download the videos they have already recorded here, and all the operations are the same as those mentioned in the <i>Image</i> above.</p> 
<p>System</p> 	<p>In System menu, users could set functions below: Time, Date, Language, Version, Reset, Update etc.</p> <ul style="list-style-type: none"> ● Double press the joystick (8) to enter the main menu. ● Move the cursor to select the System icon. ● Press the joystick (8) to enter the sub-menu of System and set the functions accordingly. 	

System 	Time	 <ul style="list-style-type: none"> ● Move the cursor to Time and press the joystick(8) for confirmation ● Press the joystick (8) forwards or backwards to set HH (hour) and MM (minute). ● Press the joystick(8) for saving your settings, and the time information on the status bar will be updated accordingly. ● Short press the joystick (8) to the left for returning to the last menu.
	Date	 <ul style="list-style-type: none"> ● Move the cursor to Date and press the joystick(8) for confirmation. ● Press the joystick (8) forwards or backwards to set YY (year), MM (month), and DD (day) . ● Press the joystick(8) for saving your settings. ● Short press the joystick (8) to the left for returning to the last menu. <p>Notes: Date format is YY (year)--MM (month)--DD (day).</p>
	Language	 <ul style="list-style-type: none"> ● Move the cursor to Lang and press the joystick(8) for confirmation. ● Press the joystick (8) forwards or backwards to set language as your need. ● Press the joystick(8) for saving your settings, and the language display of the system will change automatically. ● Short press the joystick (8) to the left for returning to the last menu.
	Version	 <ul style="list-style-type: none"> ● Move the cursor to Version and press the joystick(8) for confirmation. ● Press the joystick (8) to view the SN number and firmware version of the device ● Short press the joystick (8) to the left for returning to the last menu.

<p>System</p> 	<p>Reset</p>	 <ul style="list-style-type: none"> ● Move the cursor to Reset and press the joystick(8) for confirmation. ● Press the joystick (8) to “Y” to restore factory settings. ● Short press the joystick (8) to the left for returning to the last menu. <p>Notes: After resetting the device, some of the functions will be restored to the following states:</p> <table style="width: 100%; border: none;"> <tr> <td>✓ OLED: Gray;</td> <td>✓ Hotspot: Off;</td> </tr> <tr> <td>✓ RAV: Off;</td> <td>✓ Tracking: Off;</td> </tr> <tr> <td>✓ Zeroing distance: 25m;</td> <td>✓ Optical Zoom:1.0X;</td> </tr> <tr> <td>✓ Profile mode: A;</td> <td></td> </tr> </table>	✓ OLED: Gray;	✓ Hotspot: Off;	✓ RAV: Off;	✓ Tracking: Off;	✓ Zeroing distance: 25m;	✓ Optical Zoom:1.0X;	✓ Profile mode: A;	
✓ OLED: Gray;	✓ Hotspot: Off;									
✓ RAV: Off;	✓ Tracking: Off;									
✓ Zeroing distance: 25m;	✓ Optical Zoom:1.0X;									
✓ Profile mode: A;										

13

Reticle

Users could set several parameters of the reticle if necessary, including Type, Color, Brightness, Dot, Location, and Mode and Reversal.

13.1 Type



There are eight optional reticle types.

- ◆ Double press the joystick(8) to enter main menu.
- ◆ Move cursor to Type and press the joystick(8) for confirmation.
- ◆ Select type of reticle (1--8) as you want.
- ◆ Click Short press the joystick (8) to the left for returning to the last menu.

13.2 Color

There are five optional colors of reticle: Black, White, Red, Green, and Blue.



- ◆ Double press the joystick (8) to enter main menu.
- ◆ Move the cursor to Color and press the joystick(8) for confirmation.
- ◆ Press the joystick (8) forwards or backwards to select the reticle color as your need.
- ◆ Short press the joystick (8) to the left for returning to the last menu.

13.3 Brightness

In Brightness, users could adjust the luminance of the reticle from the value of 1 to 3.



- ◆ Double press the joystick (8) to enter main menu.
- ◆ Move the cursor to Brightness and press the joystick(8) for confirmation.
- ◆ Press the joystick (8) forwards or backwards to select the value as your need.
- ◆ Short press the joystick (8) to the left for returning to the last menu.

13.4 Dot

Dot refers to the center point of the reticle.

There are three optional dot colors: Green, Red, and Blue.

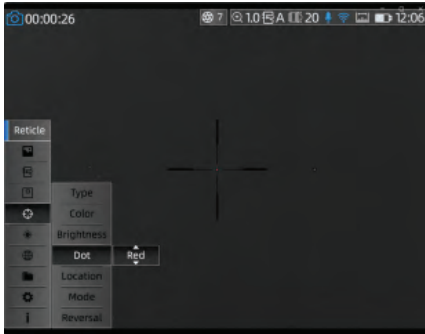

- ◆ Double press the joystick (8) to enter main menu.
- ◆ Move the cursor to Dot and press the joystick(8) for confirmation.
- ◆ Press the joystick (8) forwards or backwards to select the dot color as you need.
- ◆ Short press the joystick (8) to the left for returning to the last

13.5 Location

There are two types of reticle location: Center and Move.

- ◆ Double press the joystick(8) to enter main menu.
- ◆ Move the cursor to Location and press the joystick(8) for confirmation.
- ◆ Press the joystick (8) forwards or backwards to select the location between Center and Move.
- ◆ Short press the joystick (8) to the left for returning to the last

Notes:

- Under 1x magnification, the location of the reticle keeps the same as the zeroing coordinates. The reticles will be returned to the center of the screen when image is zoomed in.
- When zeroing is finished, the screen will be slightly enlarged based on the zeroing coordinates. The reticles will be returned to the center of the screen. When zooming in/out, the reticle will always be enlarged at the center of the OLED.

13.6 Mode

There are two reticle modes for selection: SFP and FFP.

SFP: The reticle will always keep the same size even if users change the magnification of the image.

FFP: The reticle will be enlarged as magnification changes



- ◆ Double press the joystick (8) to enter main menu.
- ◆ Move the cursor to Mode and press the joystick(8) for confirmation.
- ◆ Press the joystick (8) forwards or backwards to select the FFP or SFP as your need.
- ◆ Short press the joystick (8) to the left for returning to the last menu.

13.7 Reversal

Reticle polarity reverse helps find and lock small target. (Only for Black & White Reverse)

- ◆ Double press the joystick (8) to enter main menu.
- ◆ Move the cursor to Reversal and press the joystick(8) for confirmation.
- ◆ Press the joystick (8) forwards or backwards to ON/OFF.
- ◆ Short press the joystick (8) to the left for returning to the last menu.



14 PIP (Picture in Picture)

The image will be enlarged 2x with the reticle as the center. Picture-in-picture occupies 10% of the entire image.

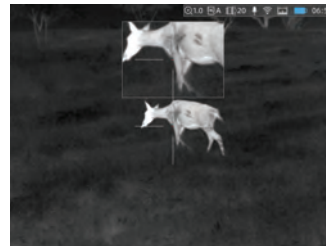

- ◆ Double press the joystick (8) to enter main menu.
- ◆ Move the cursor to Reversal and press the joystick(8) for confirmation.
- ◆ Press the joystick (8) forwards or backwards to ON/OFF.
- ◆ Short press the joystick (8) to the left for returning to the last menu.

Notice: The enlarged image will always remain on the screen when the PIP function is enabled, unless it is manually turned off.

15 Technical Inspection

It is recommended to perform a technical inspection before each use of Vidar 2.0. Please check the following items:

- ◆ The device appearance (there should be no cracks on the body).
- ◆ The condition of the objective lens and eyepiece (there should be no cracks, dirt, greasy spots, etc.).
- ◆ The condition of rechargeable battery (it should be charge normally).
- ◆ The condition of device' s joystick, buttons and other parts.

16 Maintenance

It is recommended to maintain Vidar 2.0 no less then once semiannually.

- ◆ Wipe dust off the external surfaces of metal and plastic parts with a cotton cloth. Silicone grease can be used during cleaning.
- ◆ Clean the electric contacts and battery slots on the riflescope with a non-greasy organic solvent.
- ◆ Check the optics of the lens and the eyepiece. Remove the dust and sand particles from the optics (non-contact method is recommended).
- ◆ Use specialized cleaners for the optics.

17 ThermTec Outdoor – Mobile Application

Vidar(L) 2.0 series thermal imaging scope could be interconnected with “ThermTec Outdoor” APP, which allows users to transfer files from device to smartphone or tablet via Hotspot, easily achieving remote control.

Users could download our mobile application in Apple Store and Google Play, or by scanning the QR code on the packaging or in the user manual. For more details, please refer to ThermTec website (www.thermeyetec.com).



18 Firmware Upgrade

18.1 Upgrade via PC

- ◆ Users could download the corresponding upgrade package from our website. After that, connect your device to PC via Type-C cable, and copy the firmware to device's file folder.



- ◆ Enter the Settings menu, and select Update, then there will be a pop-up window prompting “Program Updating”.
- ◆ When the update is completed, the device will automatically restart.

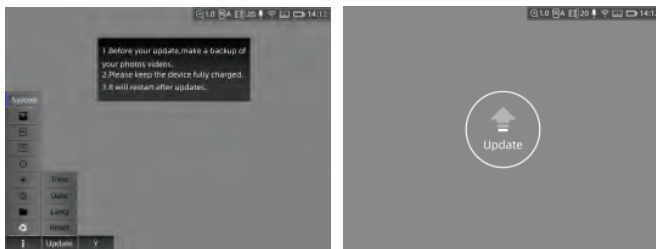

- ◆ Enter the Version menu to check the firmware version

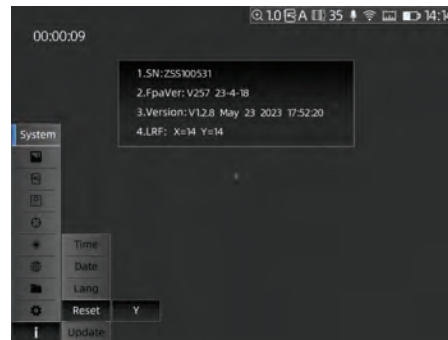

18.2 Upgrade via ThermTec Outdoor

Users could refer to the following steps to realize device firmware upgrade via our mobile APP:



- ◆ Open the ThermTec Outdoor APP.
- ◆ Turn on the device's Hotspot, and connect your mobile phone to device' Hotspot via WLAN.
- ◆ Select Update from the menu options.
- ◆ The download and upgrade process may take some time if a new firmware version is detected, so please be patient.
- ◆ Once the upgrade is complete, the device will reboot automatically.

ThermTec

DISTRIBUTED BY  **SPIKA**

contact@spika.com.au
www.spika.com.au

   SPIKA.TEAM

   ThermTec Outdoor